

THE INCREDIBLE

EGG

4-H CLASSROOM CURRICULUM GUIDE

FOR GRADE LEVEL 4-5

Extension Center

Court House

Amory, Mo. 63461

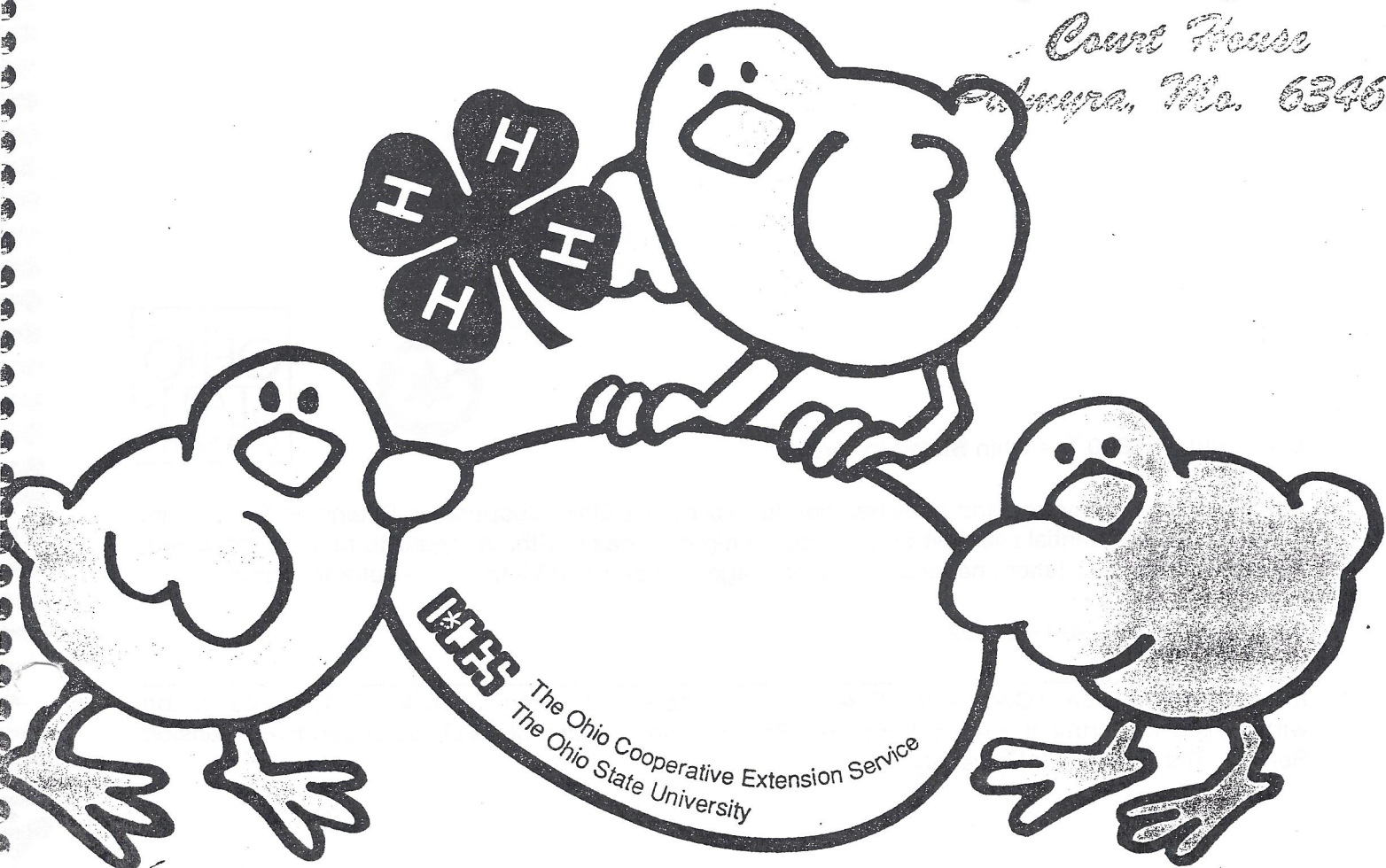



EDUCATION CURRICULUM GUIDE
LEVEL 1-8



Copyright © 1990 The Ohio State University

All educational programs and activities conducted by the Ohio Cooperative Extension Service are available to all potential clientele on a nondiscriminatory basis without regard to race, color, creed, religion, sexual orientation, national origin, sex, age, handicap or Vietnam-era veteran status.

Reprinted 11/91—4M—91602

Issued in furtherance of Cooperative Extension work, Acts of May 8 and June 30, 1914, in cooperation with the U.S. Department of Agriculture, Keith Smith, Acting Director of the Ohio Cooperative Extension Service, The Ohio State University.



Introduction

The Ohio State University and The Ohio Cooperative Extension Service are pleased to share with you a tremendous teaching resource for 4th and 5th grade classes. This unique curriculum, "The Incredible Egg," integrates the concepts of chick embryology into easy-to-use math, science and language arts lesson plans. In addition, significant learning results for this curriculum have been linked to key science program objectives (as identified in the Ohio Department of Education publication, "New Dimensions in Science Education, 1988"), in an "at-a-glance" curriculum matrix. A summary of the significant 4-H life skill outcomes that are targeted for each lesson is also provided.

The lesson plans in this package are designed to be used in sequence or as independent lessons within your classroom curriculum. For example, the lesson plans may be used to address specific math, science and language arts concepts or as a combined unit on chick embryology. Teachers using these materials as a chick embryology unit are provided a post-test to measure student achievement and a certificate of participation in this 4-H program.

One of the unique features of this curriculum is that you do not have to incubate eggs to achieve the learning objectives. However, teachers who wish to incubate fertilized eggs to increase student interest in the subject are encouraged to contact the local Cooperative Extension Service for assistance. They can assist you in locating fertilized eggs and an incubator. In fact, many county Extension offices offer training programs for conducting a classroom chick embryology program complete with Continuing Education Units (CEUs) for those who attend. Specific information on the operation of incubators and the hatching of chicks is contained with the Support Materials in the Appendix of this handbook.

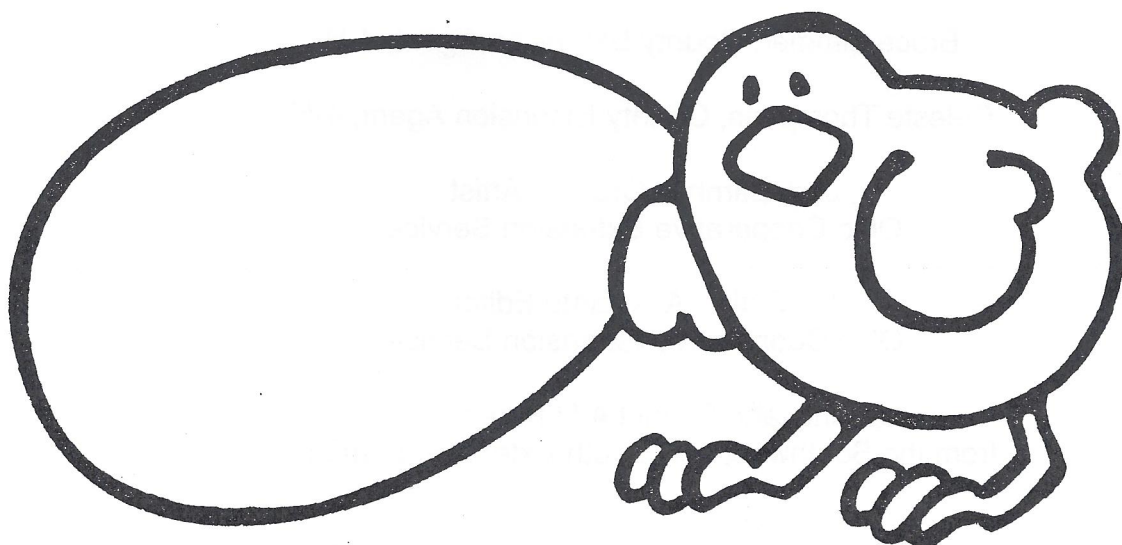

Table of Contents

Curriculum Matrix.....	4
Lesson 1: The Inside Story.....	6
Science/Language Arts	
Lesson 2: Nutrition.....	19
Science/Health/Math	
Lesson 3: Embryology.....	29
Science/Language Arts/Math	
Lesson 4: Experiments.....	44
Science	
Appendix.....	51
References.....	71

Adopted from

“The Incredible Egg”
Nebraska’s Ag In The Classroom Program
by Kathy Schellpeper, 1988

Additional Assistance from

Bob Horton, 4-H Curriculum Specialist
The Ohio State University

Phil Renner, Extension Poultry Specialist
The Ohio State University

Jeff King, County Extension Agent, 4-H

Bruce Zimmer, County Extension Agent, 4-H

Celeste Thompson, County Extension Agent, 4-H

Jodi Barnhill, Graphic Artist
Ohio Cooperative Extension Service

Liz Cutler, Associate Editor
Ohio Cooperative Extension Service

County and District 4-H Personnel
from the Southwest and South Extension Districts

Significant 4-H Life Skill Outcomes

Life Skill Areas

Targeted Lessons

◆ Learning To Learn

- Developing intellectual curiosity
- Learning through experience
- Learning by using the five senses

◆ Leading Self And Others

- Working on a team
- Identifying one's own competencies

◆ Relating To Others

- Trusting one's self and others
- Accepting diversity

◆ Communicating With Others

- Disagreeing and refusing
- Speaking before a group
- Creative expression

◆ Planning And Organizing

- Setting short-term goals

1	2	3	4
✓ ✓	✓	✓	✓ ✓
✓		✓ ✓	✓
✓ ✓		✓	✓
✓	✓	✓ ✓	✓
	✓		



The Incredible Egg

4-H Chick Embryology Program -- Biological Science

The 4-H Incredible Egg program is available through your county Extension office. It involves learning more about the egg than just how offspring are produced. Classes have the option of seeing firsthand how baby chicks are hatched. (Incubators are available through the Extension office.)

Planning Format

Grade Level 4th - 5th grade

**Goal Cluster or
Program Goals**

**Subject Area/
Objectives**

Program Objectives

Activities

Lesson One

The student will develop skills to support scientific inquiry. (1.2*)

◆ The student will recognize and be able to describe parts of the egg

Science/Language Arts

◆ Identify and name the parts of an egg.

◆ Identify the parts of the egg.
◆ Explain the functions of the parts of the egg.

Lesson Two

The students will understand and use new ideas and scientific information to improve their lives. (1.1*)

◆ The student will recognize in which food group eggs belong.

Science/Health/Math
◆ Identify the food groups to which eggs belong.

◆ Identify which food group the egg belongs to.
◆ Explain the nutritional value of eggs.

◆ The student will understand the nutritional value of an egg.

◆ Understand the nutritional value of eggs and realize how many foods use eggs as an ingredient.

◆ Record all food eaten in a two-day period.
◆ Identify which foods eaten contain eggs.

* "New Dimensions in Science Education", Division of Inservice Education, Ohio Department of Education, 1988



Goal Cluster or Program Goals

Program Objectives

Subject Area/ Objectives Activities

Lesson Three

The students develop a knowledge and understanding of scientific principles and concepts. (3.1*)

- ◆ The students will recognize how eggs are hatched.
- ◆ The students will recognize ideal incubator conditions in hatching eggs.

Science/Language/Arts/Math

- ◆ Identify the two ways in which eggs are hatched.
- ◆ Describe the incubator conditions necessary for a healthy chick to hatch.

- ◆ Describe conditions necessary for proper incubation.
- ◆ Observe the developing embryo.

Lesson Four

The students will develop a positive attitude toward science that will encourage continued interest and learning. (1.4*)

- ◆ The student will recognize the scientific method.
- ◆ The students will draw conclusions on experiments.

Science

- ◆ Use the scientific method of observing and recording during an experiment.
- ◆ Draw conclusions after the experiment.

- ◆ Record the difference between a raw and hard cooked egg.
- ◆ Observe and describe the physical aspects of the egg.

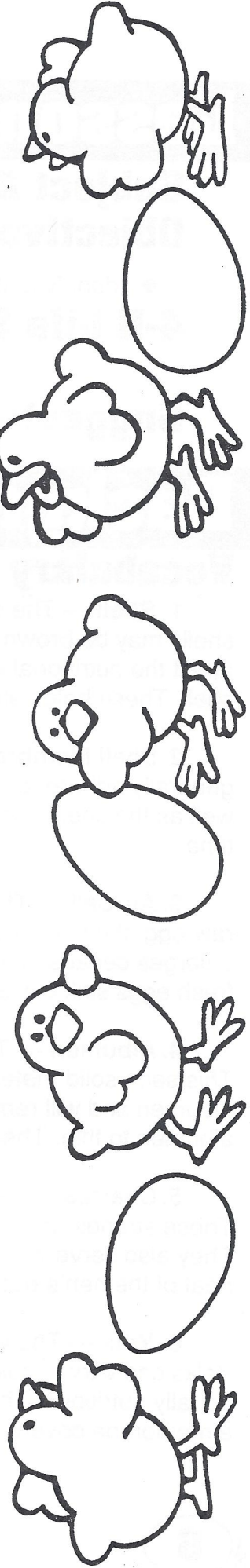

* "New Dimensions in Science Education", Division of Inservice Education, Ohio Department of Education, 1988

Lesson One The Inside Story

Subject Area: Science/ Language Arts

Objective:

- ◆ Identify and name the parts and functions of an egg.

4-H Life Skills: Learning To Learn, Leading Self And Others,
Relating To Others, Communicating With Others

Suggested Grade Level: 4-5

Background

Vocabulary

1. **Shell** — The outside protective layer of the egg. Most shells are white, but some shells may be brown or other colors, depending upon the breed of hen. Shell color does not affect the nutritional value, quality or flavor of eggs. There are tiny pores, or holes, in the shell. These holes allow air and moisture to get inside the egg.

2. **Shell Membrane** — Actually, there are two thin membranes inside the shell. These generally adhere, or stick, to the inside of the shell when a raw egg is cracked open. As well as the shell, this membrane covers and protects the developing embryo until hatching time.

3. **Air Cell** — The air cell is found at the large end of an egg. Look inside the shell of a raw egg; the shell membrane traps the air cell against the shell. As eggs age, the air cell enlarges because moisture is escaping through the shell and is replaced by air. This is why fresh eggs sink while older eggs float when put in water.

4. **Albumen** — The clear white of an egg that makes up over half of the egg's weight. This semi-solid material has a high water content. A very fresh egg has lots of thick albumen and will remain firm. Variations in storage temperature and aging can cause the albumen to thin. The albumen provides the growing embryo with food and water.

5. **Chalaza** (kuh-LAY-zee) — The two thick strands of albumen at each end of the yolk. These strands anchor the yolk in the center of the egg to keep it from touching the shell. They also serve as a rotating axis to keep the germ cell on the top of the yolk next to the heat of the hen's body. Often the chalaza are more prominent in fresh, high-quality eggs.

6. **Yolk** — The yellow of the egg that comprises about one-third of the egg's weight. Yolks can vary in color from light to dark yellow due to the hen's diet; however, all are equally nutritious. The yolk is the first part of the egg that is formed inside the hen. There is a membrane covering the yolk that is often broken when cracking an egg. For the growing

embryo the yolk provides food and protection. The yolk includes the protoplasm from which the embryo develops.

7. Germ (Blastoderm) — The white spot or portion of the yolk where an embryo can begin to develop if the egg has been fertilized and kept warm.

8. U.S.D.A. — The United States Department of Agriculture, which determines the standards for grading eggs. The most common grades are AA and A. Eggs graded AA will have yolks and albumens that stand taller and firmer than those graded A. However, both grades AA and A have the same nutritional value.

Facts About Eggs

Hens that have been mated to a rooster lay fertilized eggs. This is the way chickens reproduce. Inside each fertilized egg is a tiny speck of life that will grow to be a chick. The yellow yolk of the egg provides food for the growing embryo. The albumen, or white of the egg, provides the embryo with food and protection against shock, because it is like a watery sac. At one end of the egg is a pocket of air, the air cell. Just before the embryo breaks out of its shell, it fills its lungs with air from this air cell.

Hens that have not been mated to a rooster will still lay eggs. Because these eggs have never been fertilized, there is no life in them; thus they will never hatch. Unfertilized eggs are usually shipped to grocery stores and sold as food.

Materials

1. Chicken eggs
2. Worksheets A, B, C, D, E and F
3. Transparency A
4. Raw egg in a shell
5. Tin or black pie plate

Procedure

1. Crack the raw egg into a pie tin and place the two shell halves beside it.
2. Have students try to identify any parts of the egg and shell. At this time do not identify the parts for the students.
3. To introduce the parts of an egg, label and discuss these parts and functions on Transparency A. Have the students complete Worksheet A with you.
4. Have students look at the raw egg and shell again. See if any students can now identify the learned parts. Look for the air cell, shell pores and membranes.

5. Have students identify, locate and describe each part of the raw egg on Worksheet A.

6. Have students complete Worksheet B together.

7. Check Worksheet B together.

8. Duplicate Worksheets C and D on heavy paper. Cut out, shuffle and distribute the eggs one per student. If a student receives an egg shape with a definition, he/she needs to match with the student who has the egg shape with the term.

If a student has a term, he or she needs to find the matching definition. Give the students a certain amount of time to find their partners without talking. Have them use body and eye signals. When students match they are to stand by each other and raise their hand. If more than 16 are playing, duplicate more eggs or play in two shifts.

9. Have students complete Worksheet E.

Eggstra Activities

◆ Have the students complete Worksheet F.

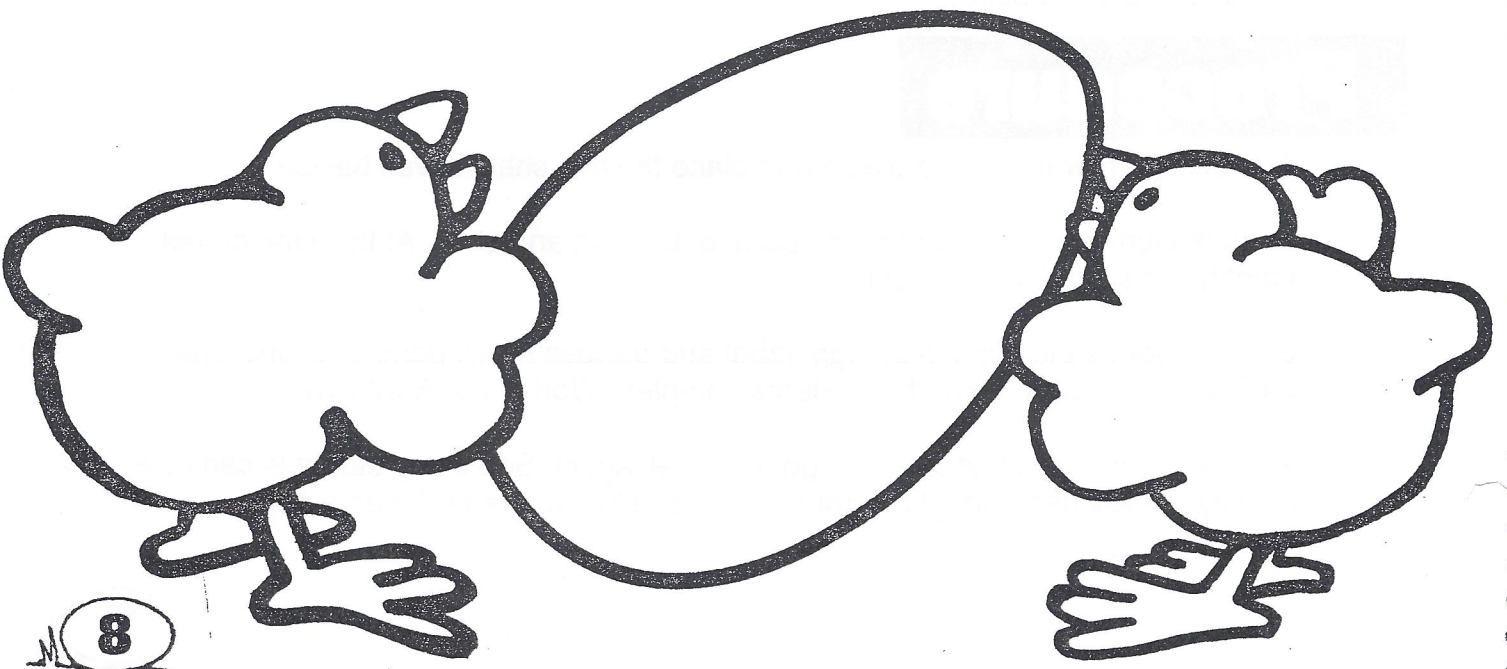

The Parts of An Egg

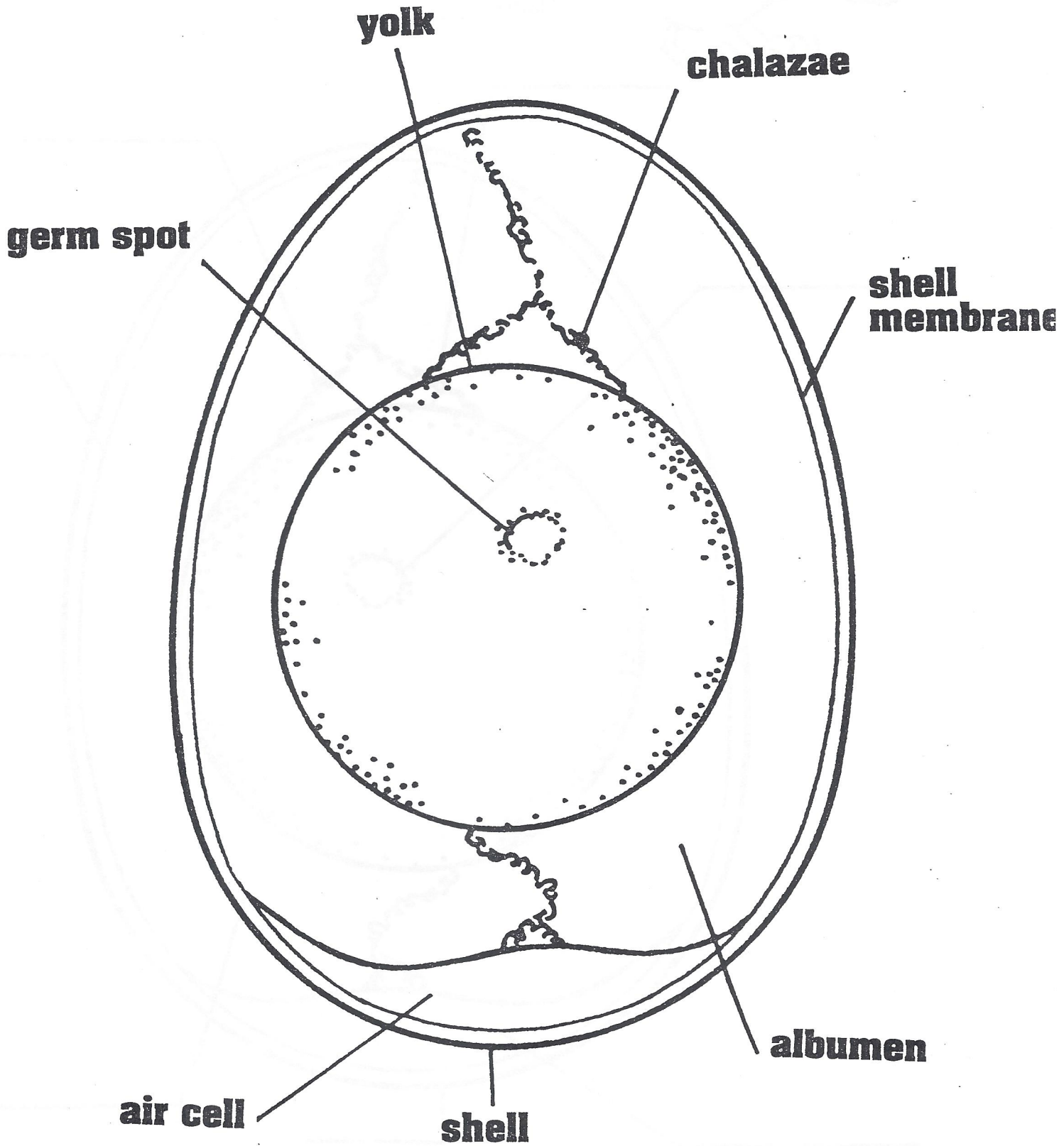

Transparency A

Adapted from: Copycat

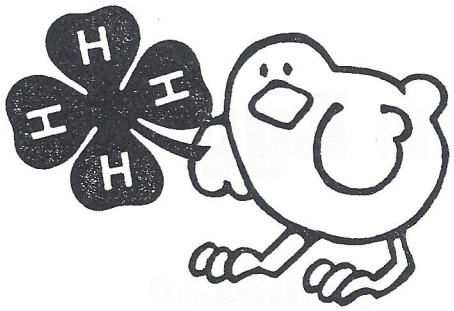

The Parts of An Egg

Name _____

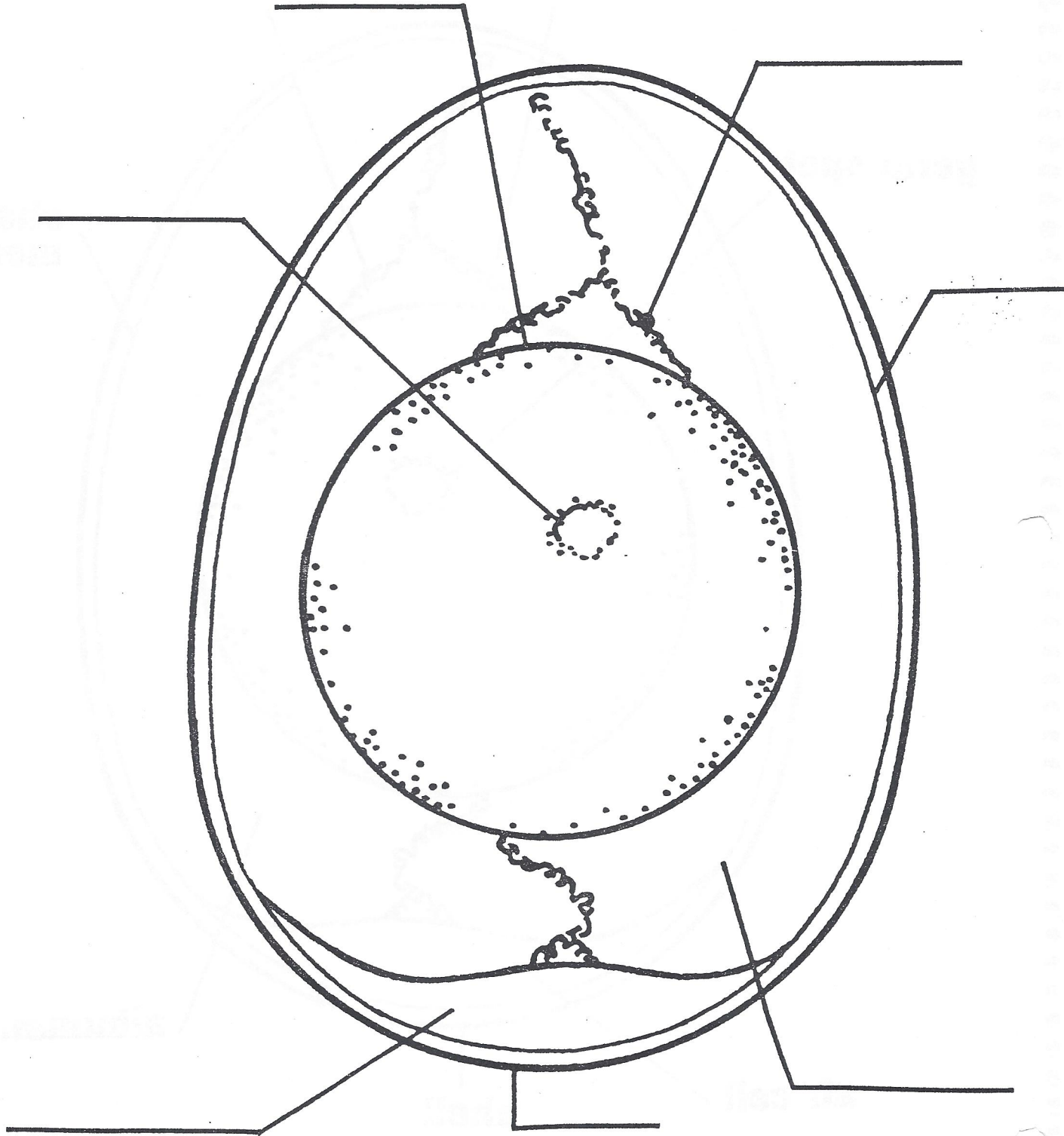

Adapted from: Copycat





Embryology Terminology

Name _____

Match the terms to the definitions by writing the correct letter in each egg shell.

 **Air Cell**

 **Albumen**

 **Chalazae**

 **Shell**

 **Yolk**

 **Shell Membrane**

 **Germ Spot**

 **USDA**

 **A and AA**

A. The white of an egg. This watery substance supplies the growing embryo with food and water.

B. The hard protective outer covering of an egg. This has tiny pores in it to allow the passage of air and moisture in and out of the egg.

C. The abbreviation for the United States Department of Agriculture.

D. The two twisted cords at each end of the yolk. These keep the yolk from moving about and sticking to the shell.

E. The yellow of the egg. This is the primary food source for the growing embryo.

F. The pocket of air at the large end of the egg.

G. Two common grades for eggs given by the USDA.

H. The "white spot" on the yolk where the embryo develops.

I. The two thin layers inside of the egg shell. Usually when the egg is cracked, this will stick to the shell.

B

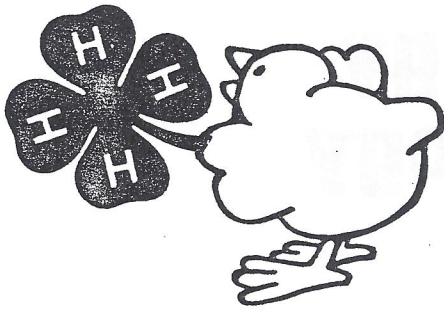

Embryology Terminology

Name ANSWER KEY

Match the terms to the definitions by writing the correct letter in each egg shell.

M. F **Air Cell**

A. The white of an egg. This watery substance supplies the growing embryo with food and water.

M. A **Albumen**

B. The hard protective outer covering of an egg. This has tiny pores in it to allow the passage of air and moisture in and out of the egg.

M. D **Chalazae**

C. The abbreviation for the United States Department of Agriculture.

M. B **Shell**

D. The two twisted cords at each end of the yolk. These keep the yolk from moving about and sticking to the shell.

M. E **Yolk**

E. The yellow of the egg. This is the primary food source for the growing embryo.

M. I **Shell Membrane**

F. The pocket of air at the large end of the egg.

M. H **Germ Spot**

G. Two common grades for eggs given by the USDA.

M. C **USDA**

H. The "white spot" on the yolk where the embryo develops.

M. G **A and AA**

I. The two thin layers inside of the egg shell. Usually when the egg is cracked, this will stick to the shell.

M. B

Air Cell

USDA

Albumen

Germ Spot

Chalazae

**Shell
Membrane**

Shell

Yolk

The pocket of air in the wide part of the egg.

The watery semi-solid white of an egg. It provides the developing embryo with food and water.

The "white spot" on a yolk. If the egg is fertilized and kept warm then the embryo will begin to develop from this spot.

The hard protective covering of the egg. This has many tiny pores that allow air and moisture to pass in and out of the egg.

The two twisted strands (cords) of albumen at each end of the yolk. These anchor the yolk in the center of the shell.

The thin layers inside the shell. When the egg is cracked, these will usually stick to the shell.

The abbreviation for United States Department of Agriculture.

The yellow of an egg. This is the primary source of food for a growing embryo.

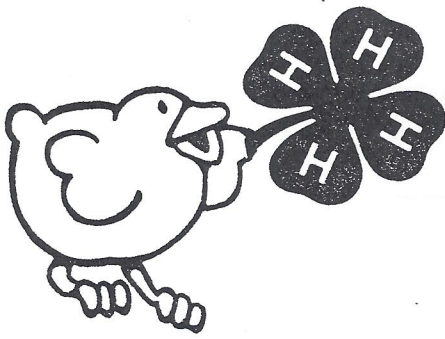

Embryology

Name _____

Eggactly how much do you remember about eggs?

Use these terms to fill in the parts of this egg.

Shell Membrane
Germ Spot
Albumen
Chalazae
Shell
Yolk
Air Cell

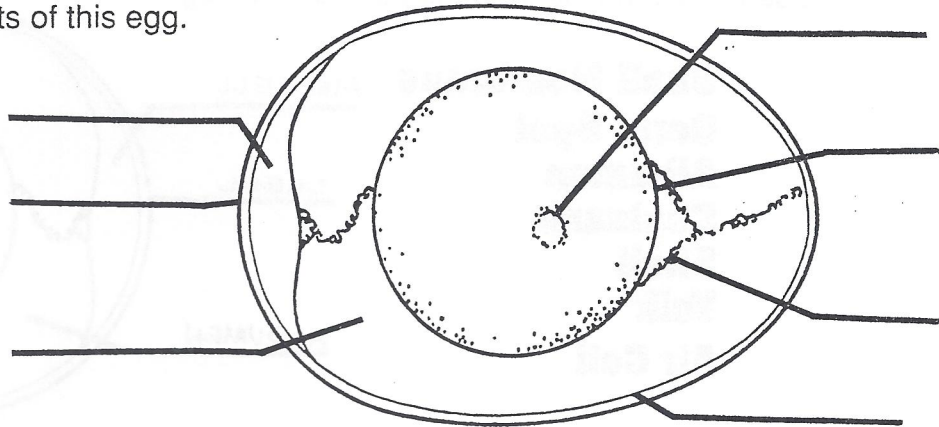

Now fill in the words from this box to make the sentences correct.

Yolk	Germ Spot	Pores	Albumen
Shells	Chalazae	AA	A
Air	Membrane	USDA	Moisture

1. The yellow of an egg is called the _____.
2. The _____ is usually called the white of an egg.
3. The _____ on the yolk is where an embryo develops.
4. Most egg _____ are white but some may be brown or other colors.
5. At each end of the yolk are _____, cords that keep the yolk from sticking to the shell.
6. Eggs are graded by the _____. Two common grades used for eggs are _____ and _____.
7. The egg shell has many tiny _____ in it to let air and _____ pass through the shell.

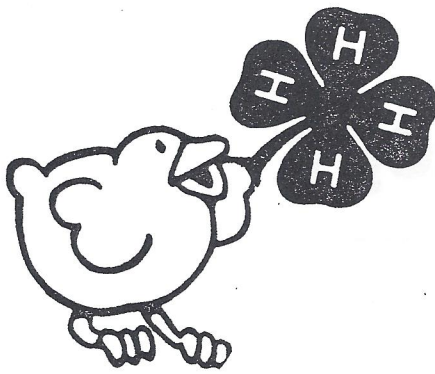

Embryology

Name ANSWER KEY

Eggactly how much do you remember about eggs?

Use these terms to fill in the parts of this egg.

Shell Membrane
Germ Spot
Albumen
Chalazae
Shell
Yolk
Air Cell

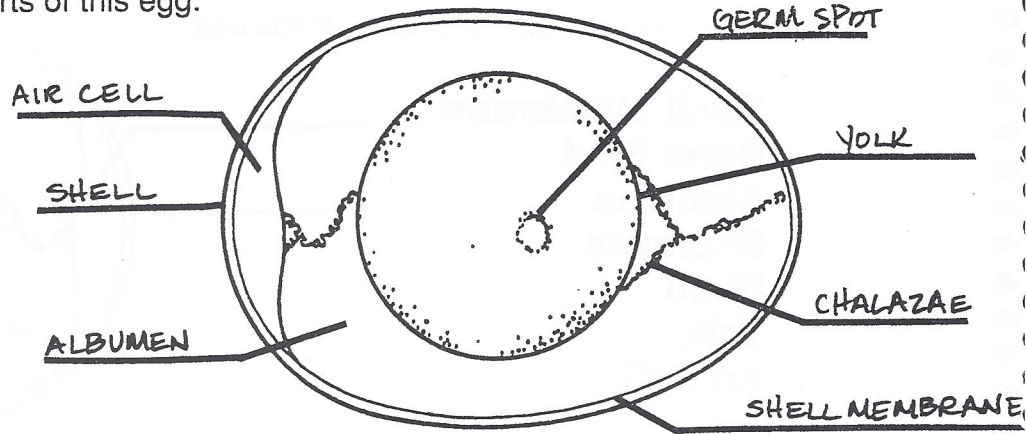

Now fill in the words from this box to make the sentences correct.

Yolk	Germ Spot	Pores	Albumen
Shells	Chalazae	AA	A
Air	Membrane	USDA	Moisture

- The yellow of an egg is called the YOLK.
- The ALBUMEN is usually called the white of an egg.
- The GERM SPOT on the yolk is where an embryo develops.
- Most egg SHELLS are white but some may be brown or other colors.
- At each end of the yolk are CHALAZAE, cords that keep the yolk from sticking to the shell.
- Eggs are graded by the USDA. Two common grades used for eggs are A and AA.
- The egg shell has many tiny PORES in it to let air and MOISTURE pass through the shell.

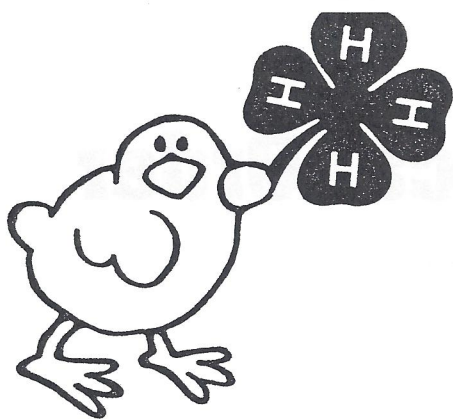

Alphabetical Order

Name _____

Put each group of words in alphabetical order.

**Shell
Moisture
Pores
Air
Membrane
Thin
Crack**

1. _____
2. _____
3. _____
4. _____
5. _____
6. _____
7. _____

1. _____
2. _____
3. _____
4. _____
5. _____
6. _____
7. _____

**White
Yolk
Egg
Albumen
Food
Chalazae
Yellow**

**Embryo
Develop
Crack
Grow
Chick
Hen**

1. _____
2. _____
3. _____
4. _____
5. _____
6. _____

Draw a crack in the egg shell if the words are in alphabetical order.

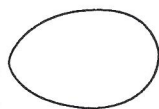

Challenge
Chalk
Chalazae

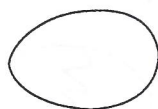

She
Shelf
Shell

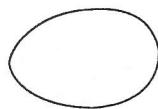

Albumen
Along
Already

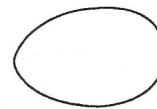

Memory
Membrane
Member

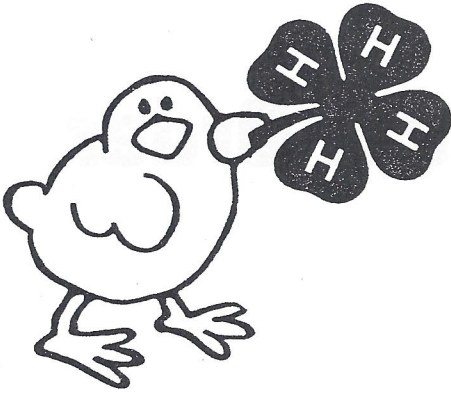

Alphabetical Order

Name ANSWER KEY

Put each group of words in alphabetical order.

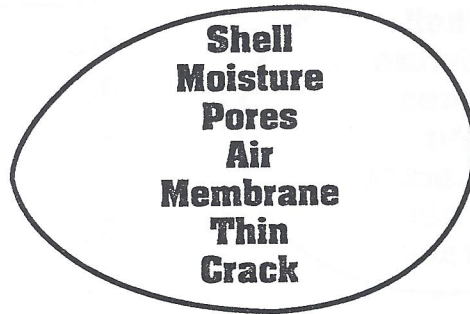

1. AIR
2. CRACK
3. MEMBRANE
4. MOISTURE
5. PORES
6. SHELL
7. THIN

1. ALBUMEN
2. CHALAZAE
3. EGG
4. FOOD
5. WHITE
6. YELLOW
7. YOLK

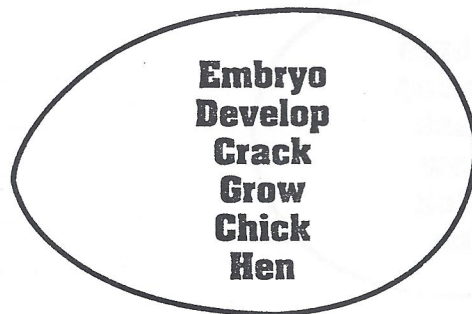
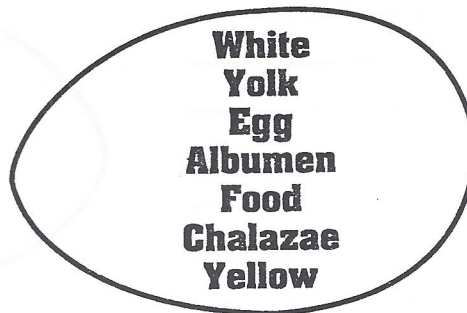

1. CHICK
2. CRACK
3. DEVELOP
4. EMBRYO
5. GROW
6. HEN

Draw a crack in the egg shell if the words are in alphabetical order.



Challenge
Chalk
Chalazae



She
Shelf
Shell



Albumen
Along
Already

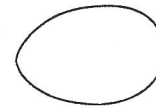

Memory
Membrane
Member

Lesson Two Nutrition

Subject Area: Science/Health/Math

Objectives:

- ◆ Identify the food groups to which eggs belong.
- ◆ Understand the nutritional value of eggs, and realize how many foods use eggs as an ingredient.

4-H Life Skills: Learning To Learn, Communicating With Others,
Planning and Organizing

Suggested Grade Level: 4-5

Background

Eggs Are Nutritional!

Eggs are among the most nutritious foods. They are a good source of vitamins A, B and D; Riboflavin, Biotin, Phosphorus and some iron are also included. Eggs are low in calories, with only about 80 in a large one, yet high in protein. In fact egg protein is extremely high in quality and includes all the amino acids needed to build and improve body tissues.

Eggs are Economical!

One dozen large eggs equals one and a half pounds of protein-rich food. If large eggs are \$1 per dozen, that is only 67 cents per pound. Of the basic four food groups, eggs are in the meat group and are an "eggcellent" meat substitute, with two eggs equaling one serving of meat.

Eggs are Incredible!

Eggs can be served any time of the day. In fact, eggs are so versatile, they can be easily prepared in a variety of ways. However, eggs like other foods, are susceptible to contamination and bacterial growth due to their concentrated content of nutrients and high quality protein. Be certain eggs are fully cooked before eating.

Resources

1. *Extraordinary Eggs*, 4-H Project Manual 488, The Ohio Cooperative Extension Service, The Ohio State University, 1988.

Materials

1. Daily food intake charts (Worksheet H)
2. Cookbooks
3. Transparency B
4. Worksheet G

Procedure

1. Discuss and decide to which food group eggs belong.
2. Discuss the nutritional value of eggs and the role some nutrients play in maintaining a human body using Transparency B. You may wish to have students complete Worksheet G as you discuss this topic.
3. Have each student keep track of all the food consumed in a two-day period of time using Worksheet H.
4. Later, go over each student's food intake chart to survey the amount of food each student eats that contains eggs. Use the cookbooks for reference. (Students may be surprised with the amount of eggs they have eaten.)

Eggstra Activities

- ◆ Worksheets I and J (math story problems)
- ◆ Prepare eggs before class by soaking them in vinegar for 48 to 72 hours in a refrigerator. The acid in the vinegar will decalcify the shells making them soft and semi-permeable. In class, let your students gently handle the softened eggs so they can observe the differences between an ordinary egg shell and the decalcified shell.
- ◆ Conduct the separation experiment with your class entitled "Making Meringue," on page 28.

Eggs— A Natural Wonder

Shell

- ◆ Outer covering of egg, composed of calcium carbonate
- ◆ Color does not affect quality, cooking characteristics or nutritional value

Yolk

- ◆ Color varies with feed of the hen, but doesn't indicate nutritional content
- ◆ Major source of vitamins, minerals and fat

Chalazae

- ◆ Prominent chalazae indicate high quality

Aircell

- ◆ Increases in size with age

Shell Membranes

- ◆ Provide protective barrier against bacteria

Thin Albumen (White)

- ◆ Spreads around thick white of high quality egg

Thick Albumen (White)

- ◆ Excellent source of riboflavin and protein
- ◆ Stands higher and spreads less than thin white in high quality eggs
- ◆ Thins and becomes indistinguishable from thin white in low quality eggs

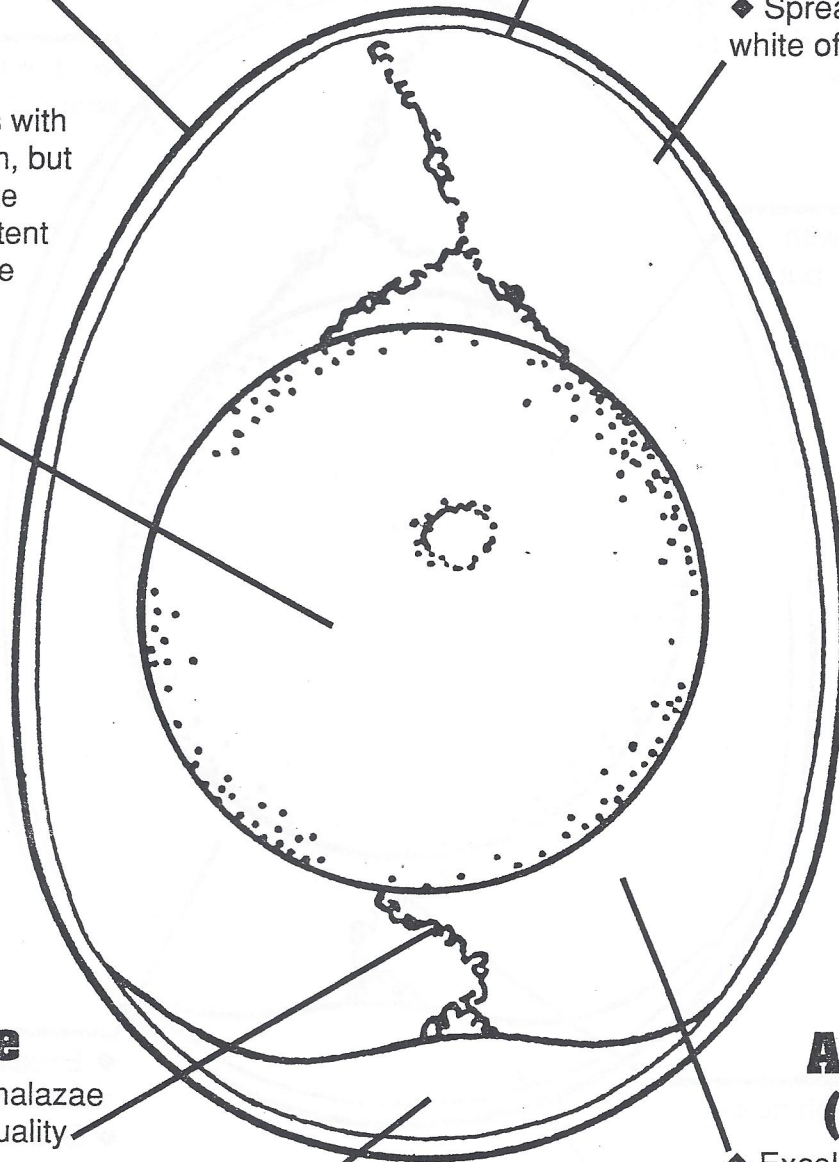

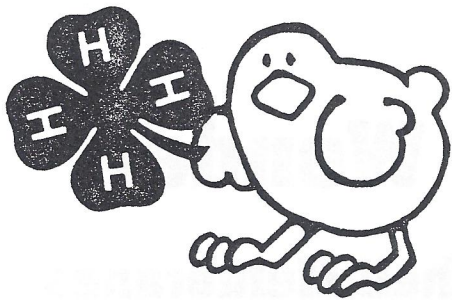

A Natural Wonder

Name _____

- ◆ Outer covering of egg, composed of calcium carbonate
- ◆ Color does not affect quality, cooking characteristics or nutritional value

- ◆ Provide protective barrier against bacteria

- ◆ Spreads around thick white of high quality egg

- ◆ Color varies with feed of the hen, but doesn't indicate nutritional content
- ◆ Major source of vitamins, minerals and fat

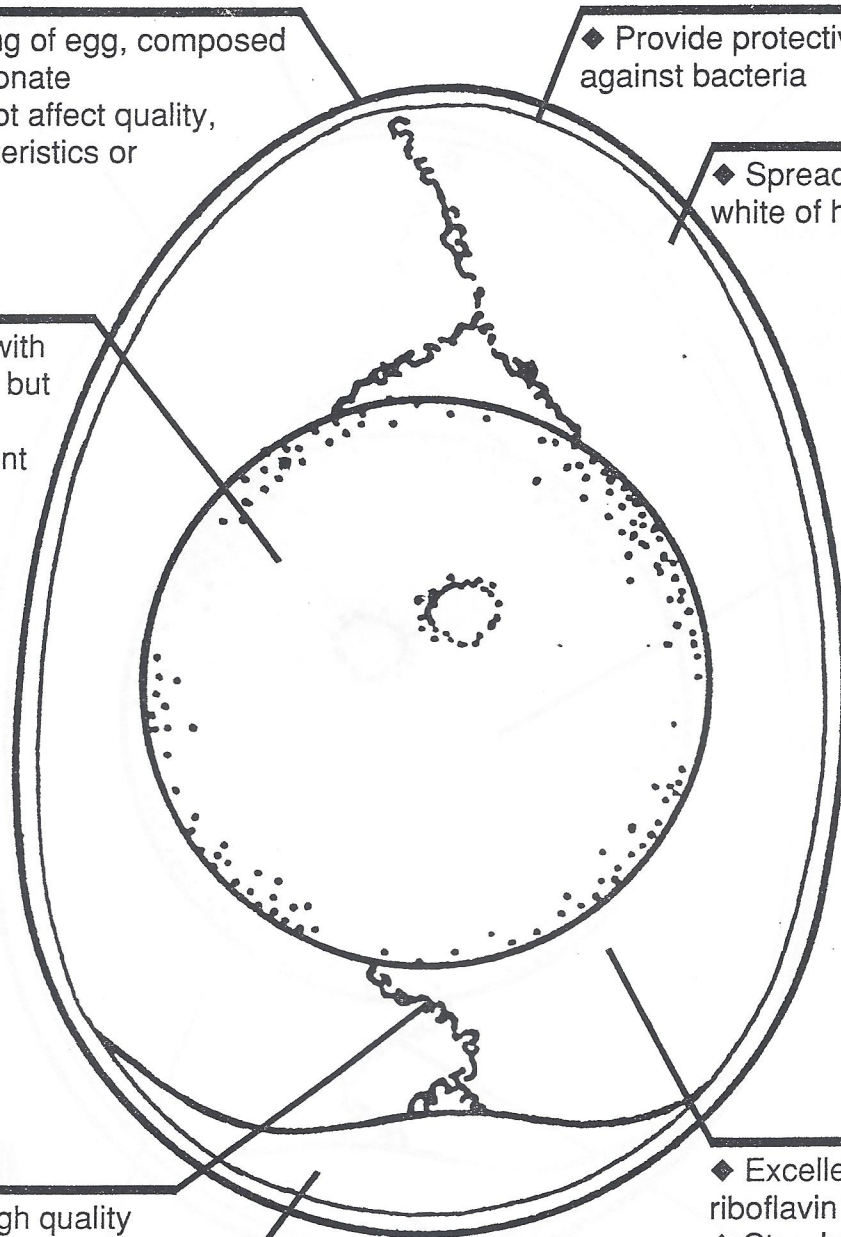

- ◆ Indicator of high quality

- ◆ Increases in size with age

- ◆ Excellent source of riboflavin and protein
- ◆ Stands higher and spreads less than thin white in high quality eggs
- ◆ Thins and becomes indistinguishable from thin white in low quality eggs

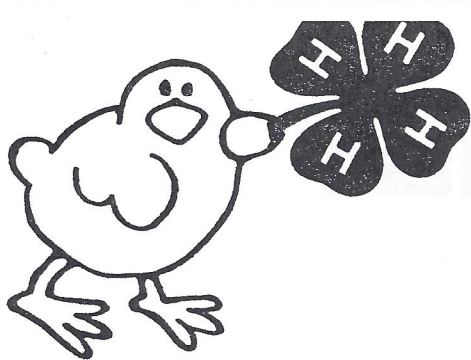

Daily Food Intake

Name _____

	Day 1	Day 2
Breakfast		
Lunch		
Supper		
Snacks		

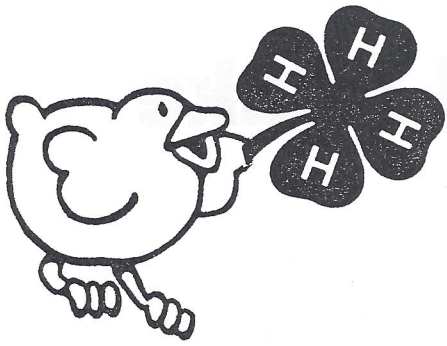

Eggstra Math

Name _____

Read each problem carefully. Show your work below the crack in the shell.
Remember to label your answers.

There are 12 eggs in a dozen. How many eggs are in
2 dozen?
3 dozen?
4 $\frac{1}{2}$ dozen?

If medium eggs are on sale for 49 cents a dozen, how much will three dozen eggs cost?

The Tri-Food Store sold 1,488 eggs on Wednesday and 1,548 eggs on Friday. How many more did they sell on Friday?

How many dozen eggs can Andrew buy if they sell for 66 cents a dozen and he has \$2? Will he receive any change back? If so, how much?

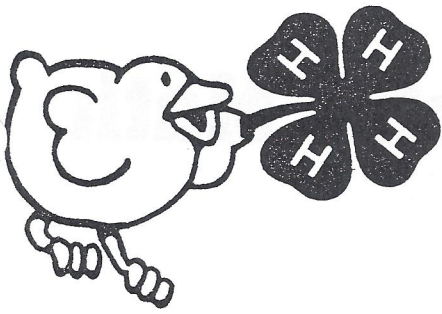

Eggstra Math

Name ANSWER KEY

Read each problem carefully. Show your work below the crack in the shell. Remember to label your answers.

There are 12 eggs in a dozen. How many eggs are in
2 dozen? 24
3 dozen? 36
4 1/2 dozen? 54

$$\begin{array}{r} 12 \\ \times 2 \\ \hline 24 \end{array}$$
$$\begin{array}{r} 12 \\ \times 3 \\ \hline 36 \end{array}$$
$$\begin{array}{r} 12 \\ \times 4 \\ \hline 48 \\ + 6 \\ \hline 54 \end{array}$$

If medium eggs are on sale for 49 cents a dozen, how much will three dozen eggs cost?

$$\begin{array}{r} \$0.49 \\ \times 3 \\ \hline \$1.47 \end{array}$$

The Tri-Food Store sold 1,488 eggs on Wednesday and 1,548 eggs on Friday. How many more did they sell on Friday?

$$\begin{array}{r} 1548 \\ - 1488 \\ \hline 60 \text{ EGGS} \end{array}$$

How many dozen eggs can Andrew buy if they sell for 66 cents a dozen and he has \$2? Will he receive any change back? If so, how much?

$$\begin{array}{r} \$0.66 \\ \times 3 \\ \hline \$1.98 \end{array}$$

3 DOZEN

$$\begin{array}{r} \$2.00 \\ - 1.98 \\ \hline \text{YES} - 2\text{¢} \end{array}$$

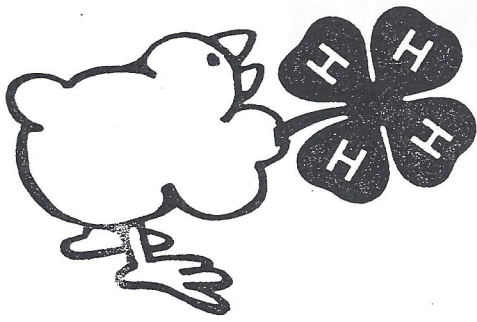

More Eggstra Math

Name _____

Read each problem carefully. Show your work below the egg. Remember to label your answers.

Marvin delivers eggs to grocery stores. He delivered 326 dozen to IGA, 450 dozen to HyVee and 298 dozen to Super Saver. How many dozen eggs did he deliver in all?

There are 80 calories in a large egg. If Mrs. Shell eats three eggs, how many calories did she gain?

Mike and Terry are stacking egg cartons. Mike stacked 136 cartons and Terry stacked 98 cartons. How many more does Terry need to stack to have more than Mike?

Amy wants to cook breakfast for herself and six guests. She will fry two eggs for each person. How many eggs will she need to fix?

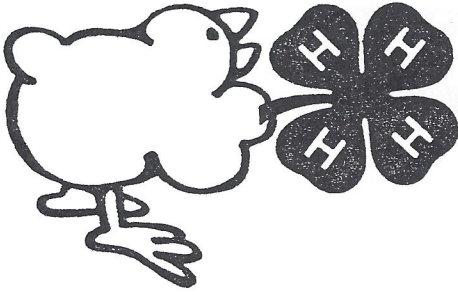

More Eggstra Math

Name ANSWER KEY

Read each problem carefully. Show your work below the egg. Remember to label your answers.

Marvin delivers eggs to grocery stores. He delivered 326 dozen to IGA, 450 dozen to HyVee and 298 dozen to Super Saver. How many dozen eggs did he deliver in all?

1,074 EGGS

$$\begin{array}{r} 326 \\ 450 \\ + 298 \\ \hline 1,074 \end{array}$$

There are 80 calories in a large egg. If Mrs. Shell eats three eggs, how many calories did she gain?

240 CALORIES

$$\begin{array}{r} 80 \\ \times 3 \\ \hline 240 \end{array}$$

Mike and Terry are stacking egg cartons. Mike stacked 136 cartons and Terry stacked 98 cartons. How many more does Terry need to stack to have more than Mike?

38³⁹ EGG CARTONS

$$\begin{array}{r} 136 \\ - 98 \\ \hline 38 \end{array}$$

Amy wants to cook breakfast for herself and six guests. She will fry two eggs for each person. How many eggs will she need to fix?

14 EGGS

$$\begin{array}{r} 7 \\ \times 2 \\ \hline 14 \end{array}$$

Separation Experiment

Making Meringue

Discussion

The white of an egg is the albumen. It surrounds the yolk in four layers and contains half the protein of the egg, some of the minerals and vitamins, a large quantity of water and a little fat.

Before egg whites are beaten, they contain curled-up molecules of protein. Beating changes the molecules by unrolling them until they resemble stretched-out fibers. Still attracted to each other, the thread-like molecules form a three-dimensional network. In this structure, the molecules trap the air beaten into the egg white. When cooked, the molecules become rigid, making the structure permanent.



Molecules Before Beating

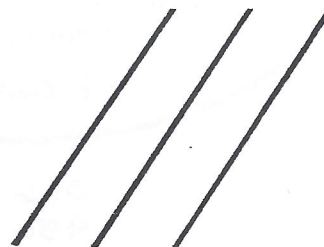

Molecules After Beating

Classroom Demonstrations

1. Separate the whites from several room temperature eggs and beat in front of the class. You may wish to have some students help you separate the whites from the yolks. Before beating, try to get the students to guess how long it will take for the whites to “whip up.” Try the experiment again with eggs kept in the refrigerator. Have students determine if temperature has an affect on the expansion of egg whites.

2. Use a clear glass beaker to show what happens when egg whites are boiled in muddy water. Have students watch as the albumen coagulates, trapping the impurities within it.

Lesson Three Embryology

Subject Area: Science/Language Arts/Math

Objective:

- ◆ Be able to identify the two ways in which eggs are hatched (incubator and hen).
- ◆ Be able to describe incubator conditions needed for a healthy chick to hatch.

4-H Life Skills: Learning To Learn, Leading Self and Others,
Relating To Self and Others, Communicating With Others

Suggested Grade Level: 4 - 5

Background

Hatching

Eggs are hatched in two different ways — by a broody hen and by an incubator. Today, however, very few chicks are hatched by hens. It would be impossible to raise the millions and millions of new chicks needed every year by hatching a few eggs at a time under hens. Instead, professional hatcherymen and poultry breeders use huge electric incubators that can hatch thousands of eggs at a time.

Egg Tooth

The hard white spot on the top of the embryo's beak. It is used to pip, break and crack the shell during hatching.

Embryology

A science that deals with the growth and development of a chick.

Step By Step

Day 3

The body is shaped like a backwards question mark surrounded by blood vessels in the yolk sac. The head and heart begin to form.

Day 4

All the organs (digestive tract, nervous system, etc.) are present.

Day 5

The face and nasal parts begin to take shape.

Day 6

The beak begins to form. The brain is present but without a skull. The eyes have formed, but without eyelids. Leg and wing buds are present. All parts of the chick have now begun to develop.

Day 9

The chick is complete except for feathers and growth.

Day 12

Eyelets now cover the eyes. Hair-like feathers cover the skin.

Day 14

The embryo situates itself in the shell so its head is by the air cell at the large end of the egg.

Day 15

The body is covered with down feathers. The egg tooth is formed. The feet now have toe nails.

Day 16

The albumen is almost gone — the yolk is the primary food source for the chick.

Day 17

The head is under the right wing and the beak is turned toward the air cell at the large end of the shell. At the end of this day, the water pan should be filled and sponges placed in it. The incubator should now be kept closed until the hatched chicks are dried off and ready to be moved.

Day 18

The embryo is full-grown and ready to begin the hatching process.

Day 20

The yolk sac is drawn into the embryo's body; it will need this food for energy during the hatching process. The embryo now takes up all the space except the air cell. It may begin to pip the shell membrane with its egg tooth. Once broken, the embryo will fill its lungs with oxygen from the air cell.

Day 21

Hatching time! The embryo's normal position before hatching is to have its head under the right wing at the large end of the egg. The legs are up over its abdomen. The embryo uses its egg tooth to pip (break or chip) almost all the way around the inside of the shell. Then by kicking, it emerges out of the shell all wet and tired. For many hours it will need to rest and dry off into a fluffy yellow chick. It needs to be kept in the warm incubator until completely dry.

Temperature

Most incubators need to run at 100.5° F. In this type of situation the top of the eggs will be about 100° F, but the bottom of the egg may only be 94° F. The middle of the egg may be 98° F. Over-heating will speed up the rate of development, causing abnormal embryos, lower hatchability or early death.

Humidity

Humidity is important for normal embryo development. The relative humidity of air within the incubator for the first 18 days should be about 60 percent. A variation of 5 to 10 percent will probably not hurt. Low humidity causes too much loss of water from the egg, while high humidity does not allow enough water loss. In both cases, hatchability is reduced; but it is better to have humidity too high than too low. A pan of water in the incubator will insure moisture in the air. The eggs, however, should not come into direct contact with the water.

Turning the Eggs

Turning prevents the embryo from sticking to the shell. Good results can be obtained by turning the eggs the first thing in the morning, again at noon and the last thing at night. Turn them at least three times a day (preferably five to seven times a day). Always turn the eggs an odd number of times each day so at night the chick will be laying differently than the night before. They only need to be turned until the end of the 17th day. After that the embryo can move enough on its own without sticking to the shell. Rotating the eggs at least once a day is important because the temperature is not always even throughout the incubator.

Ventilation

As the embryo grows, it uses oxygen and gives off carbon dioxide. Thus, efficient ventilation within the incubator is required to assure an adequate supply of oxygen in the air.

Resources

1. *The Avian Embryo*, Extension Bulletin 633, The Ohio Cooperative Extension Service, The Ohio State University, 1978.

Materials

1. Worksheets K, L, and M
2. Transparency C

Procedure

1. Discuss the conditions necessary for proper incubation (found in the background section of the lesson)
 - a. temperature
 - b. humidity
 - c. turning and rotating the eggs
 - d. ventilation
2. Have students complete worksheet K, then review them together.
3. Discuss the development of the embryo using Transparency C and the background information.
4. Have students make a booklet from Worksheets L.
5. Duplicate and complete certificate "The Egg-ceptional Award" on page 41 for each student who completes this unit.

Eggstra Activities

- ◆ Have students use the information from this list to make a graph. Use the least number of days when an approximation is given.

Bird	Days
Chicken	21
Turkey	28
Duck	28
Muscovy Duck	33-35
Goose	29-31
Guinea	26-28
Pigeon	16-18
Ring-Necked Pheasant	23-24
Mongolian Pheasant	24-25
Bobwhite Quail	23
Japanese Quail	17-18
Chuckar Partridge	22-23
Peafowl	28

- ◆ Have students copy and illustrate this poem.

Baby Chick

Peck
peck
peck

on the warm brown egg.
OUT comes a neck.
OUT comes a leg.

How
does
a chick,

Who's not been about,
discover the trick
of how to get out?

-by Aileen Fisher

Taken from: *Widening Circles* Level 8
Teachers Edition,
Harcourt Brace Jovanovich
©1979 HBJ, Inc.

- ◆ Assign Worksheet M to be completed at home or in groups during class.

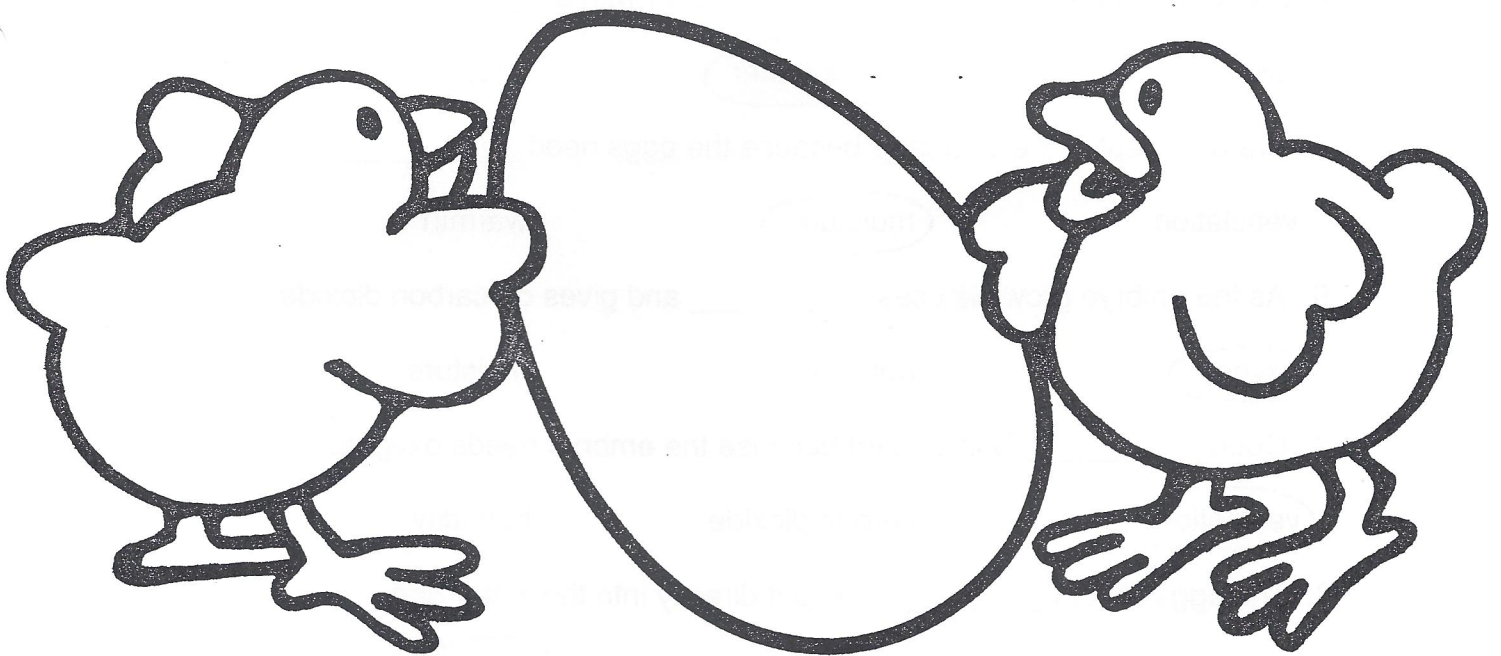

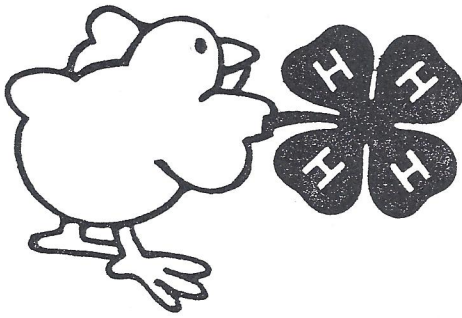

Incubation

Name ANSWER KEY

Complete each sentence below by circling the correct answer.

1. A human-made container for hatching eggs is _____.

an aquarium

an incubator

a thermometer

2. Embryology is the study of the development of _____.

an embryo

an insect

a reptile

3. It takes _____ days to hatch chicken eggs.

12

31

21

4. The temperature in the incubator is measured with a _____.

ruler

thermometer

scale

5. Water is kept in the incubator because the eggs need _____.

ventilation

moisture

warmth

6. As the embryo grows it uses _____ and gives off carbon dioxide.

oxygen

humidity

moisture

7. Good _____ is important because the embryo needs oxygen.

ventilation

carbon dioxide

humidity

8. The eggs should _____ be put directly into the water pan.

always

sometimes

never

9. The eggs in the incubator should be turned _____ times a day.

one

two

three

10. Turning the eggs prevents the embryo from _____.

getting too big

sticking to the shell

sleeping

12. The eggs in the incubator should always be handled _____.

gently

roughly

with gloves

13. The eggs should be _____ once a day because the temperature in the incubator is not always even.

removed

cracked

rotated

14. The embryo pips (breaks) open the shell with its _____.

egg tooth

feet

wings

15. After the chick hatches, it will be _____.

ready to play

learning to fly

wet and tired

16. The _____ is the main source of food for the growing embryo.

chalazae

yolk

albumen.

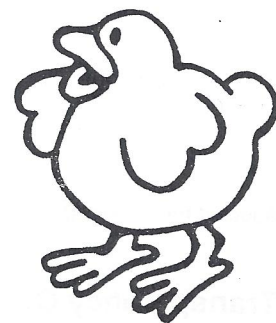
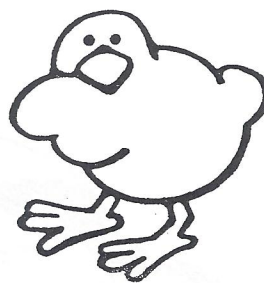
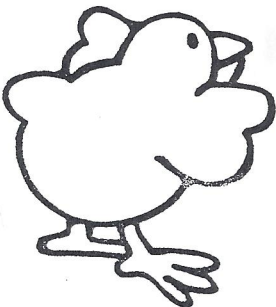

The Developing Embryo

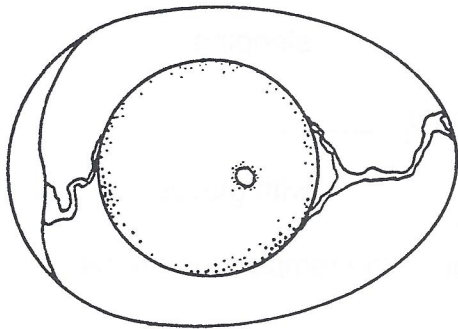

Day 1

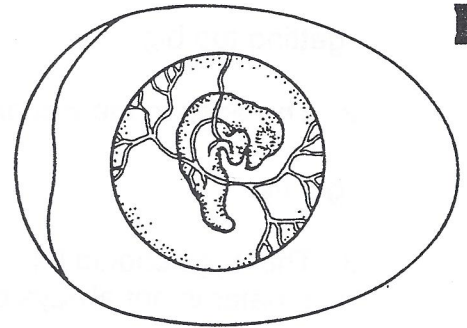

Day 3

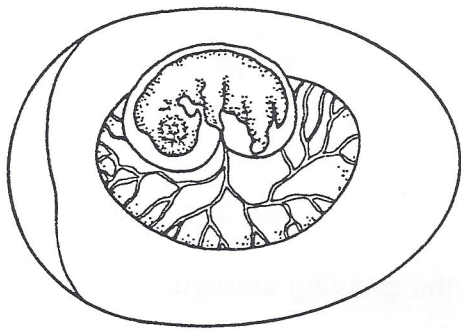

Day 6

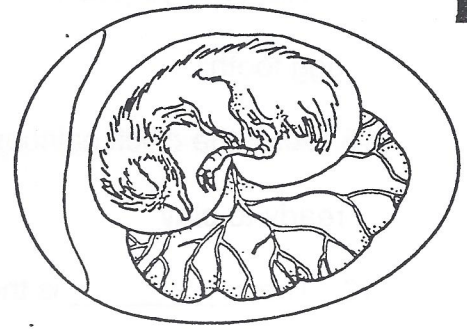

Day 13

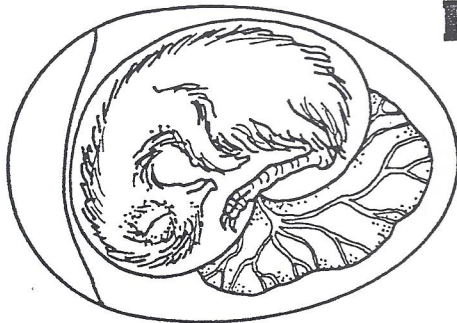

Day 16

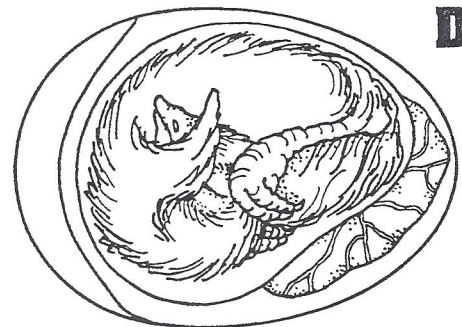

Day 19

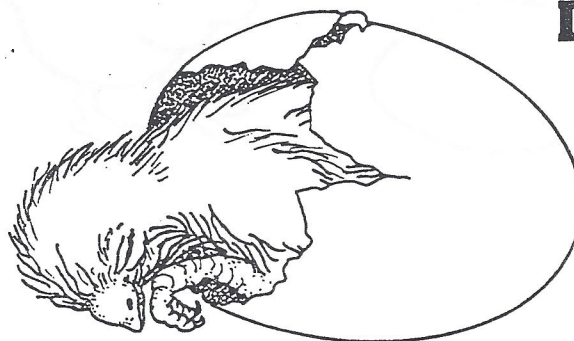

Day 21

Adopted from Copycat

Transparency C



The Egg-ceptional Award

Presented To

On This Day

For

Teacher

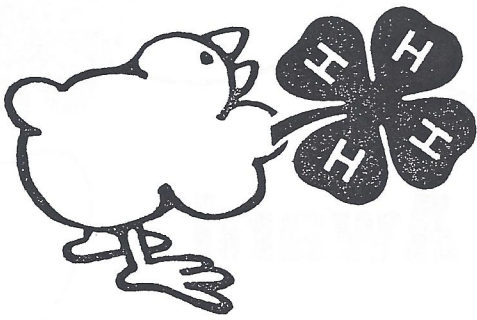

Egg-U-Bation

Name _____

The incubator allows us to hatch millions and millions of chicks each year.
Can you find what makes an incubator work?

(words can be spelled vertical, horizontal, diagonal, backward and forward)

B G Q E C R T D X V E Y S F W Z
G R W R O T A T I O N H K I A M
J O K U L A B U M J B N V L T O
F U P T H E R M O M E T E R C Y
E P H S R G P C Q I D O N N H T
S W T I U X W D V E C F T Y F I
Z O B O G J P E L U K Z I Y U C
Q R R M V B M G D I E T L A L I
S K W Z A I Z G O W A D A W N R
X V G C T C W S M B N J T X E T
W H U I W M K N T J E S I R S C
A J C D B Q C N E G Y X O X S E
R E T A B X K G X K O J N H B L
M L Q S R Y F J R P Z W F D G E
T N K P R E Q S T U D E N T S J
H A O M Y T I D I M U H C I E Z

Check List

Eggs
Thermometer
Watchfulness

Time
Rotation
Electricity
Students

Ventilation
Groupwork
Humidity
Oxygen

Moisture
Care
Warmth

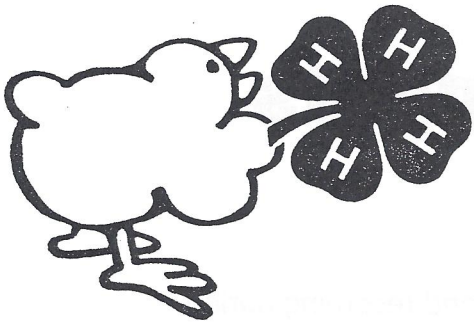

Egg-U-Bation

Name ANSWER KEY

The incubator allows us to hatch millions and millions of chicks each year.
Can you find what makes an incubator work?

(words can be spelled vertical, horizontal, diagonal, backward and forward)

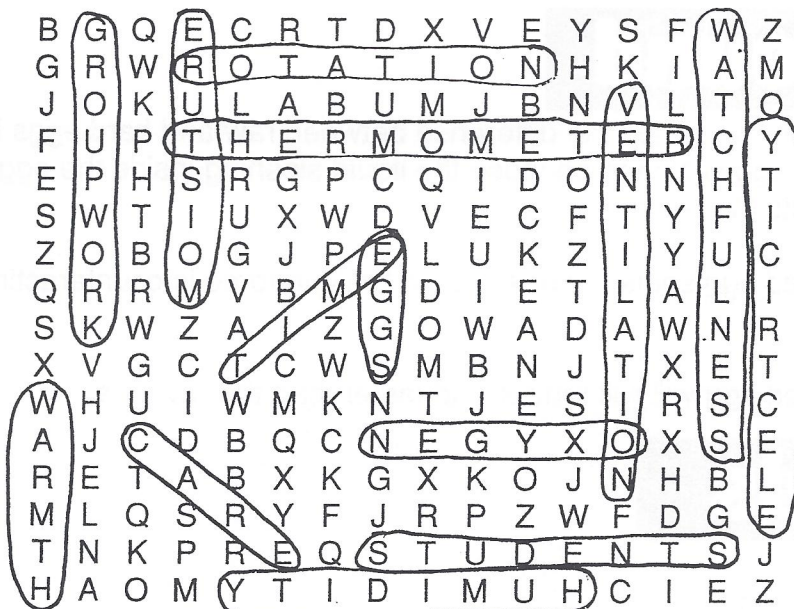

Check List

Eggs
Thermometer
Watchfulness

Time
Rotation
Electricity
Students

Ventilation
Groupwork
Humidity
Oxygen

Moisture
Care
Warmth

Lesson Four Experiments

Subject Area: Science

Objective:

1. Be able to use the scientific methods of observing and recording during an experiment
2. Be able to draw conclusions after the experiment

4-H Life Skills: Learning To Learn, Leading Self and Others,
Communicating With Others

Suggested Grade Level: 4 - 5

Background

1. The only reliable way to tell the difference between raw and hard eggs is by spinning; the raw egg is slower because the liquid sloshing inside the egg creates resistance as it hits the walls.
2. The hard-cooked egg spins faster since no braking force is counteracting the momentum.
3. The hard-cooked egg will roll farther and faster than the raw one.

Materials

1. 4 raw eggs
2. 4 hard-cooked eggs
3. Flashlight
4. Worksheet N

Procedure

Experiment One

1. Label one hard-cooked egg "A" and one raw egg "B." Set up the eggs and the flashlight in a darkened corner of the classroom. Send the students to the corner to complete Experiment One on worksheet N.

Materials

1. Several raw eggs of different grades
2. Six to eight books
3. Foam padding or two halves of a racquetball
4. Long board
5. Worksheet O

Procedure

1. Discuss how easily eggs seem to break. Ask how many students have accidentally broken eggs. Then ask for suggestions on how many pounds a raw egg can hold before cracking. Write these on the blackboard.
2. Gather the students around the experiment so everyone can see the materials. Keep the room quiet so they can hear the egg crack.
3. For each egg, jot down its size, grade and shell color on the chalkboard. The students will need the data to fill in the chart for the strongest egg.
4. Next, assemble materials as shown in illustration below. Support one end of the board with books at a height of about one foot. On the opposite end, sandwich an egg end to end (cushioned between two pieces of foam or the halves of a racquetball) between two books. Make sure the ends of the board are level.
5. Once assembled have a smaller student walk across the board. If the egg does not break, try a larger student. Have students estimate the amount of pressure the egg withstood.
6. Repeat the experiment with the other eggs. Was there much difference? Discuss why. (The size of the egg and the thickness of the shell affects its strength.)
7. Finally, ask the students to fill out the certificate on Worksheet O using the data for the strongest egg.

Setup for Walking on Eggs

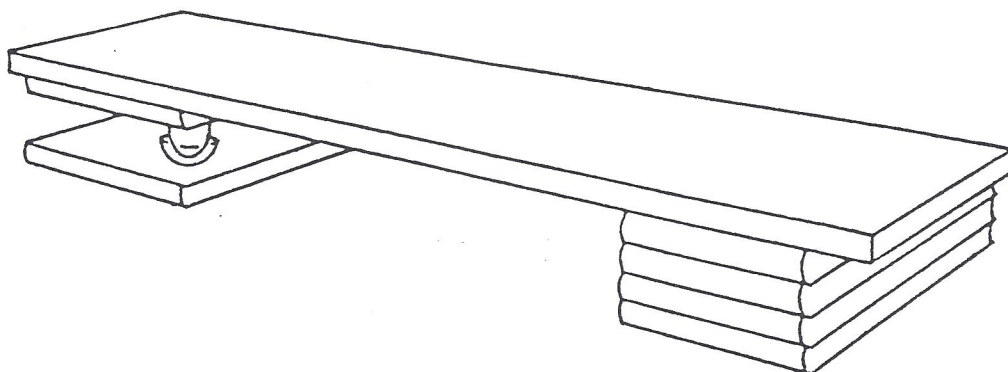

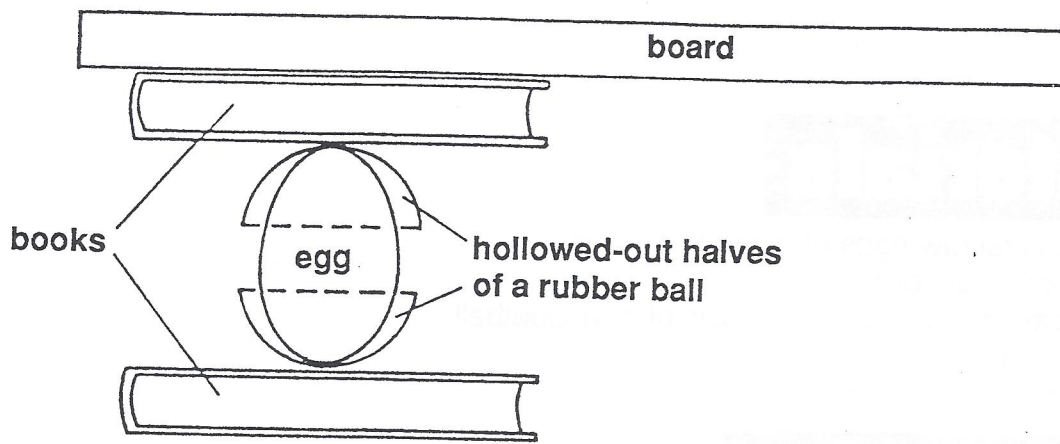

Additional Facts

1. **Cosmetic** — Egg white has long been used as a facial. Egg yolk is used in shampoos and conditioners.
2. **Animal Feed** — Both shells and interiors of eggs are used.
3. **Experimental Uses** — Egg white is used as a protein reference in feeding laboratory animals. Egg yolk and egg products are used in laboratories as a medium for the growth of microorganisms.

Eggstra Activities

- ◆ Have the students cut out all clear eggs on Worksheet P. Have them match the blackened eggs to an antonym and the clear eggs to a synonym on Worksheet Q. Check to see that all students have correct matches. Have them fold up the wide end of each egg and paste the eggs at the narrow ends to form a flip-up activity they can practice on at home.
- ◆ Have students see if they can balance an egg on one end. After several attempts, have them prick the egg at one end with a needle. This will cause the yolk to break and redistribute the weight of the egg. The egg will become bottom-heavy and can be easily stood on its end.

Day 1

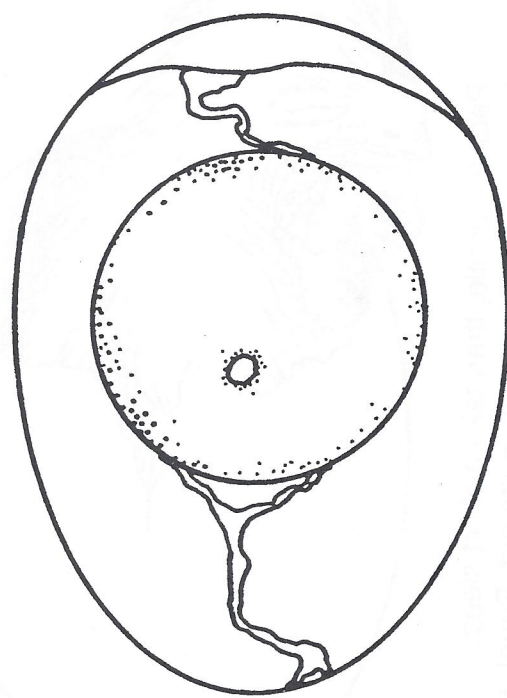

Baby Chick, baby chick, when will you hatch?
Did you begin with this little white patch?



What's Inside?

What is inside of this little eggshell?
A new baby chick! This story will tell.

Day 6

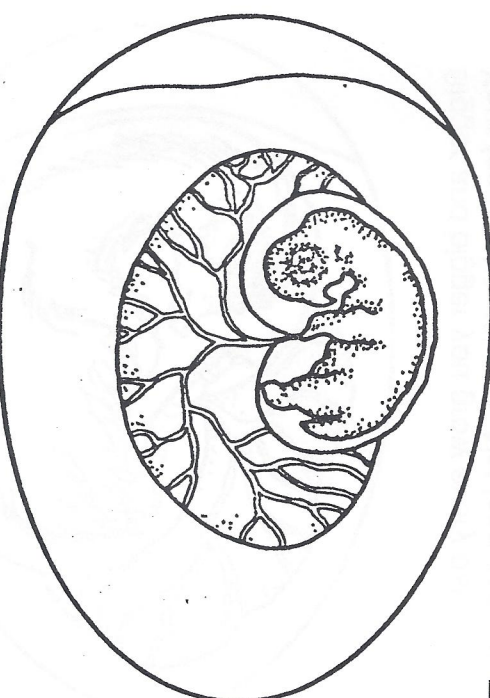

More days for growing, almost a week.
You now have two wings, two legs and a beak.

Day 3



You're very tiny but warm as can be.
Your heart and your head we begin to see.

Day 13

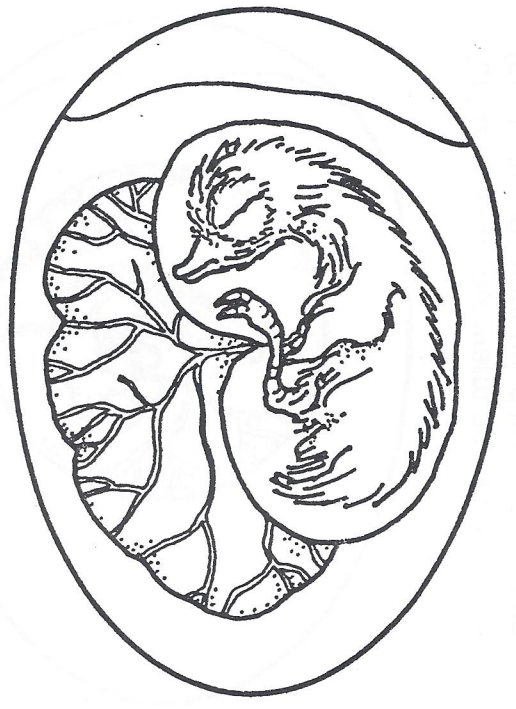

Soon you have feathers, and claws on your toes.
Oh, my, how fast a new baby chick grows!

Day 16



Bigger and bigger you grow every day.
Your food's almost gone. Not long can you stay.

Day 19



This shell is too small. You're too big to fit.
You're just about ready to hatch out of it.

Day 21



Peck for awhile, then take a short sleep.
You work very hard and you're out. Peep! Peep!

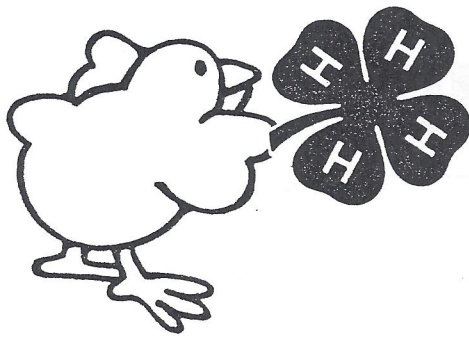

Let's Eggs-Periment

Name _____

How well do you notice details? Can you figure why something happens? These experiments will give you a chance to be a scientist. Watch what happens in each experiment and then answer the questions.

Experiment 1

Raw or Hard-Cooked?

1. Look at both eggs closely. Do you see anything that tells you which one is raw?

2. Shake each egg carefully. Can you feel a difference? _____

If you can, which one is raw? _____

3. Hold each egg in front of the flashlight. Does more light show through one of them? _____ If so, which one? _____

4. Spin each egg on the floor away from tables and chairs. Do they both spin the same? _____ If not, which one was slower? _____

Do you think the slower egg is hard-cooked or raw? _____

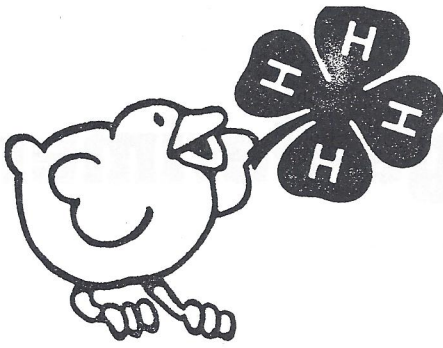

Super Egg!

Name _____

Official Results

As a scientist and honest reporter, I am officially recording the facts of my experiment. On _____, a test of
date
strength was given to an egg with these characteristics:

size _____

grade _____

shell color _____

This egg held up until _____ pounds were put on it.

Therefore, this egg has been named "Super Egg of the Day."

Scientist _____ Witness _____

Date _____ Witness _____

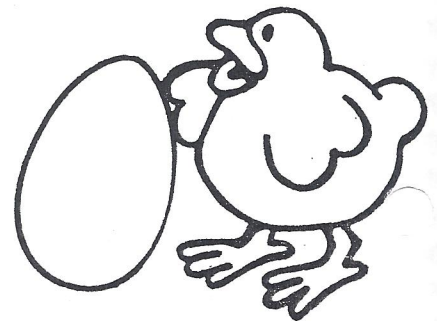

Passive

Death

Old

Hen

Firm

Asleep

Cold

Moist

Antonyms are words that have opposite meanings. Example: big-small.

Synonyms are words that have similar (like) meanings. Example: noisy-loud.

Fowl

Weak

Feed

Circulate

Watchfulness

Turn

Break

Permeable

Dry

Chicken

Rooster

Care

Active

Crack

Awake

Rotate

Porous

Soft

Birth

Ventilate

Warm

Food

Young

Feeble

Q

Appendix

Support Material

For use when conducting as a Chick Embryology unit where fertilized eggs are incubated and hatched

- ◆ Incubation/Embryology Check List
- ◆ Incubator Daily Record
- ◆ Reasons For Poor Hatches
- ◆ After The Chicks Hatch
- ◆ Questions Most Asked By Teachers
- ◆ Questions Most Asked By Students

Follow-up Material

- ◆ Certificate of Participation
- ◆ Follow-up Worksheets
- ◆ Post Test

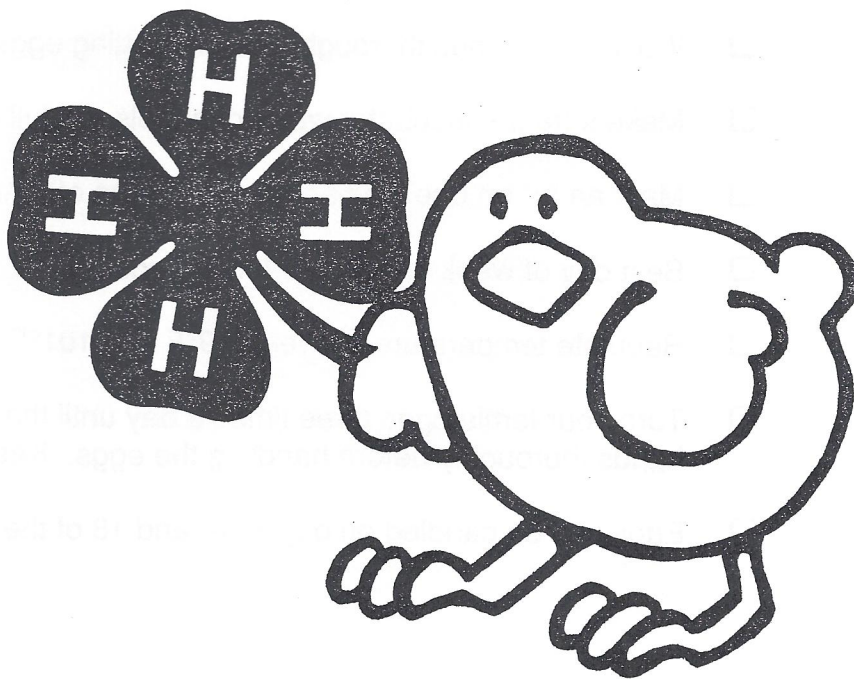

Incubation/Embryology Checklist

Pre-Hatch Checklist

When you receive your incubator

- Wash it thoroughly with a damp cloth using a diluted Chlorox solution, then let dry.
- Set up away from drafts, direct sunlight and traffic paths.
- Regulate the temperature between 99° F to 101° F two or three days before you begin incubation of fertile eggs. Maintain room temperature between 70° and 75°F.
- Make sure you have a reliable and accurate thermometer.
- Be sure the thermometer is placed at egg level.
- Fill rings in bottom of incubator with distilled water and keep full.

Incubation and Hatching Checklist

- Wash your hands thoroughly before setting eggs in the incubator.
- Make sure the incubator water channels are full of water.
- Mark an "x" on one side and an "o" on the other side of each egg with a pencil.
- Best day of week to set your fertile eggs is on a Tuesday or Wednesday.
- Regulate temperature between 99°F and 101°F, most preferably at 100.5°F.
- Turn your fertile eggs three times a day until the 18th day of incubation. Wash your hands thoroughly before handling the eggs. Keep records on turning the eggs.
- Eggs can be candled on day 7, 14 and 18 of the incubation period.

- On the 18th day, place a thin layer of cheese cloth over the wire rack, then place the eggs on the cheese cloth.
- Add wet sponges to bottom of incubator to increase moisture, and if your incubator has vent plugs, remove them as appropriate.

Post-Hatch Checklist

- Set up a brooder box.
- Acquire feed in advance of hatch.
- Place fresh cat litter, cedar or wood shavings in the bottom of the brooder box.
- Regulate the temperature around 95°F.
- Provide water for chicks after they are placed in the brooder box.
- Decide in advance of hatch what you will do with the baby chicks.
- After hatch, clean your incubator with a diluted Chlorox solution.

This information was adapted from material prepared by Gary S. Davis, North Carolina State University
K.W. Koelkebeck
Incubation-Embryology Series
1-13-89

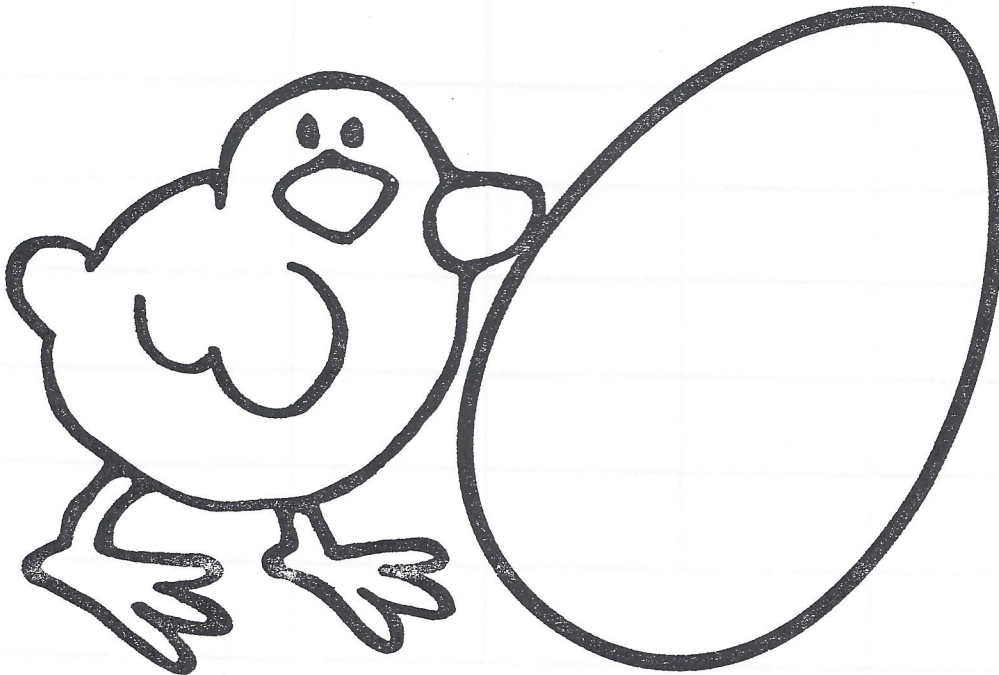

Reasons For Poor Hatches

Poor results in hatching are commonly caused by the improper control of *temperature* or *humidity*. Improper control means the temperature or humidity is too high or too low for such a long period of time that it interferes with the normal growth and development of the embryo.

To obtain the best possible hatch, keep the temperature as near 100.5°F as possible for the entire incubation period. There will be fluctuation of two or three degrees above and below 100°F, but there should not be prolonged periods of high or low temperature. High temperature is especially serious.

An incubator that is run warm, constantly averaging a bit above 100.5°F, will tend to produce an early hatch. One that is run cold, a bit below 100.5°F, will tend to produce a late hatch.

To obtain the proper temperature reading, place the bulb of the thermometer so it is on a level with the place where the embryos will begin to develop in the eggs. This is approximately 1/4-inch below the top surface of the shell when the egg is on its side. This applies to chicken, duck, pheasant, quail and other species' eggs. The bulb of the thermometer should not be in contact with an egg.

Check the thermometer! Is it accurate? An error of one degree for 21 days can seriously interfere with embryo growth.

To check the incubator thermometer, place the bulb next to the bulb of a clinical (the oral kind used to check body temperature) or a laboratory thermometer. Hold under luke-warm tap water and compare the readings. Make an adjustment for any error in the incubator thermometer.

A thermometer in which the mercury column is split *will not* give an accurate reading. It is no good; dispose of it.

Rarely is the humidity too high in a still-air incubator. Normally, it tends to be low. Thus, the water pan should cover at least one-half of the surface area of the incubator.

The humidity should be raised during the last three days of incubation. Adding another water pan or a wet sponge helps to do this. Embryos need considerable moisture to hatch properly and easily. High humidity tends to produce a late hatch; low humidity an early hatch.

DO NOT turn the eggs the last three days of incubation. The embryos are moving into hatching position and do not need to be turned. Keep the incubator closed to maintain proper temperature and humidity, but DO NOT seal it tightly because the embryos need oxygen.

Don't forget to place a cloth (crinoline is best) on the screen floor of the incubator. This protects the navel, the place where the abdomen closes after surrounding the remains of the yolk, from injury. It also makes cleaning the incubator easier.

The longer eggs are held before setting, the lower the fertility will be. Try to set eggs before they are ten days old. At three weeks, the fertility will drop to zero.

Allow the newly hatched chicks to dry out in the incubator until they fluff up. Then place them in a brooding unit.

For additional information, refer to Extension Publication 633, *The Avian Embryo*, Ohio Cooperative Extension Service, The Ohio State University, 1978.

This information was adapted from material prepared by E. A. Schano, Cornell University.

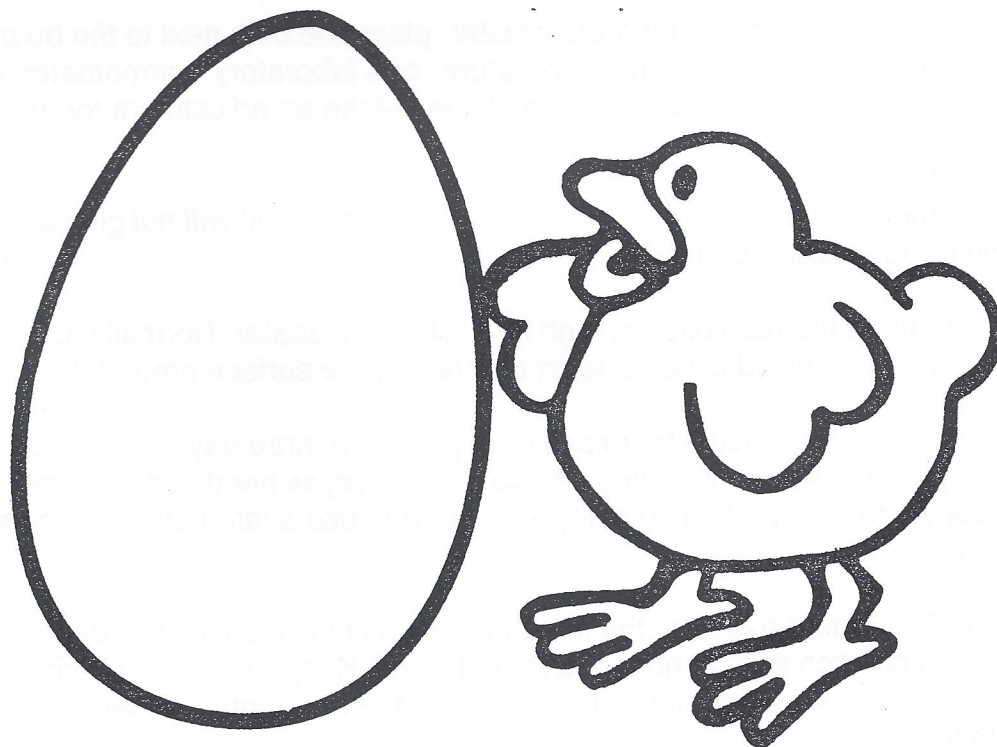

After The Chicks Hatch

Adapted from *The Avian Embryo*, Extension Bulletin 633, The Ohio Cooperative Extension Service, The Ohio State University, 1978

Brooding Chicks For A Few Days

Live chicks may be kept for display and additional study if proper care and facilities are provided. It is important to protect, feed and water them to ensure their comfort. Remember to find a good permanent home for the chicks after the period of classroom observation is over. If no appropriate home for the chicks can be found, it is better to destroy them than allow them to suffer and die through maltreatment.

Although there is no definite period of brooding, a maximum of 10 days is probably enough time for students to gain insights into the chicks' behavior, eating habits, etc.

Equipment and Supplies for Brooding Up To 12 Chicks

- ◆ Container approximately 28"x25"x14"
- ◆ Gooseneck lamp with a 60-75 watt lamp to keep chicks warm
- ◆ Shavings as litter material — large enough so chicks won't eat them
- ◆ Feed Tray — shallow yet sturdy so chicks won't upset it
- ◆ Feed — chick starter
- ◆ Waterer — closed system preferably so chicks won't step in it

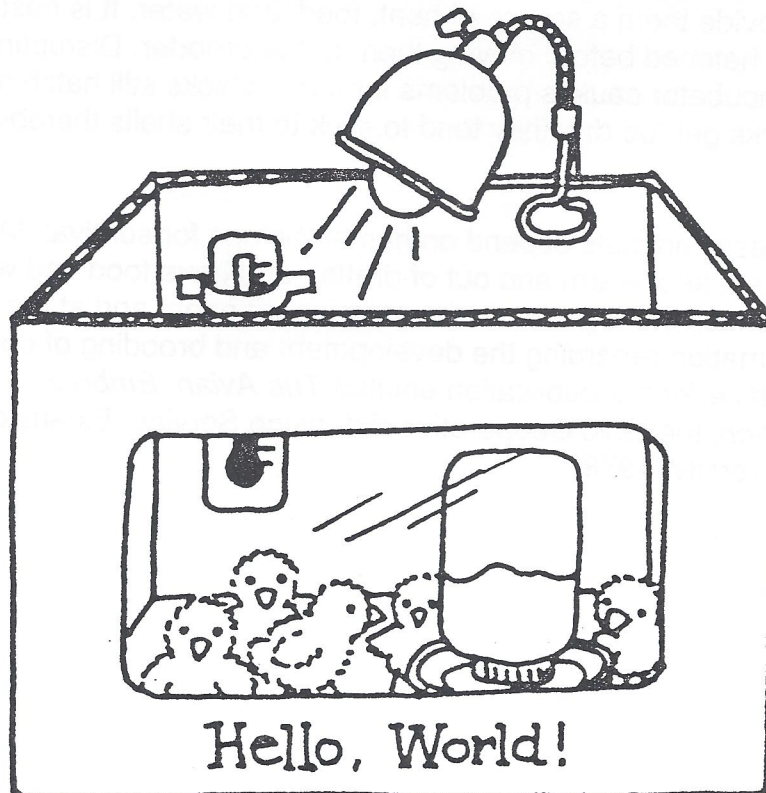

Procedure

A simple brooding unit may be used to keep a few chicks for a short period of time. The principles of brooding are the same regardless of the number of chicks in the flock. The above figure shows a set-up of a simple brooder. The shape and quality of the container is not as important as long as it is large enough to house the chicks and adequately contain the equipment.

Note the position of the lamp. Chicks must be able to get away from direct heat, so having the lamp at one end with a slightly cooler area at the other end of the container is advisable. A 60-75 watt bulb will normally provide enough warmth. The neck of the lamp should be adjustable so that it can be moved closer to the chicks if they appear cold. Comfortable chicks are usually distributed evenly throughout the floor area of the brooding unit rather than clustered together.

Ideal Temperature

Age of Chicks	Temperature
1 day to 1 week	95° F
1 week to 2 weeks	90° F

When To Place Chicks In Brooder

Once chicks have hatched and appear dry, remove them from the incubator and place them into the brooder. This will give them the chance to move freely without disturbing the other eggs as well as provide them a source of heat, food, and water. It is best to wait until two or three chicks have hatched before moving them to the brooder. Disrupting the environment within the incubator causes problems for those chicks still hatching. For example, if hatching chicks get too dry, they tend to stick to their shells thereby lessening their chances for escape.

Remember, all domestic animals depend on human beings for survival. Make sure the chicks are properly housed, kept warm and out of drafts, and have food and water. This means having students check the brooder in the morning, at noon, and at the end of the day. For additional information regarding the development and brooding of chicks contact your county Extension office for the publication entitled *The Avian Embryo — A Manual of Embryology and Incubation*, the Ohio Cooperative Extension Service, Extension Bulletin 633, The Ohio State University, 1978.

Questions Most Often Asked By Teachers

1. Humidity — How do you know what's enough or too much?

In small classroom incubators, there is no exact or precise way to measure humidity. Hygrometers do not work well in these incubators. If you have a factory-made incubator, keep water in the receptacle(s) all the time. If you have made your own incubator, use a water pan or pans equal in size to at least one-half and preferably more of the incubator's floor space. During the last three days of incubation, place moist sponges or cloths in the incubator to increase humidity but don't let the sponges or cloths come into contact with the eggs.

2. Is the Cornish breed of chickens in the English class the ones that are sold as Cornish hens?

Not the pure Cornish. A cross of Cornish and usually White Plymouth Rocks are used to produce the Cornish hen, also called Rock Cornish and Rock Cornish Hens. Rock Cornish Hens are actually small broilers.

3. What breed of chickens is used for cock fighting?

Fighting cocks come mostly from varieties of, or crosses with, the Old English breed. It should be noted that it is illegal to fight cocks in Ohio, and in fact, even to breed or keep fighting cocks.

4. How many eggs can be set in an incubator?

The rule of thumb is that an average "Large" egg placed on its side (long axis) covers 3-3/4 square inches. So, by calculating the floor area of an incubator in square inches and dividing by 3-3/4, the approximate number of eggs is estimated. However, the space required for two eggs should be subtracted to allow for the space taken up by the thermometer.

5. How can a person tell a fertile egg from an infertile one? When an egg was fertilized?

It is not possible to visually distinguish between fresh, whole fertile and infertile eggs. After they have been incubated three days, a small reddish area with blood vessels extending from it will be visible in fertile eggs when they are candled or broken out; infertile eggs will be clear. When broken out, fresh infertile eggs show a smaller, whiter germ spot than fertile ones because cell division has not occurred in the infertile ones but has in the fertile ones, making their germ spots larger and not as pure white. There is no practical way to tell when an egg was fertilized.

Questions Most Often Asked By Students

1. Can two chicks hatch from one egg?

Yes. It is a rare occurrence. When two chicks hatch from the same egg, the egg usually has two yolks. The development of twin chicks from single-yoked eggs is very infrequent; and when it does occur, the single yolk has two blastoderms (fertilized germs). We have no knowledge of Siamese twin chicks ever being hatched.

2. What is a double-yolked egg?

It is an egg that has two yolks in it. Both yolks were ovulated (released) at or about the same time and enclosed in the same shell. Many eggs with double yolks occur when young adult female chickens first start producing eggs. Their egg-forming organs are not adjusted or not yet synchronized, so two yolks are released together. Shortly after egg production starts, the chickens' bodies adjust, and for the most part, they then lay eggs with only one yolk. But, there are some chickens which inherit the characteristic to lay double-yolked eggs and continue to do so throughout their life.

3. If a female chicken is hatched with about 4,000 ova and lays only 240 to 250 eggs a year, what happens to the remainder of the ova?

Depending on the state of health and condition of the chicken, they can continue to exist in the hen's body ready to form a yolk or they can be absorbed by the hen's body.

4. Can I hatch the eggs I buy at the store?

No. The eggs in grocery stores are infertile and will not hatch.

5. If a mother hen sits on a fertile egg, will it always hatch? If not, what does she do with it?

Not all fertile eggs will hatch even when incubated either by a broody hen or in an incubator. Under some conditions they will contain weak or defective embryos. Hatchability is influenced by (1) age of eggs at setting; (2) conditions under which they were held before incubation; (3) parent stock, including its breeding potential, health and diet; and (4) conditions while the eggs are being incubated. So, the fact that a hen is doing the incubating does not guarantee that a fertile egg will hatch. If an egg or eggs do not hatch, the hen eventually leaves them and the nest. She leaves because the hormone that caused her to go broody is no longer secreted, so she stops setting on the eggs. In a way, it could be said that nature has told her to quit the nest.

6. How long can the mother hen be off the nest during the day? What will happen if she stays off too long?

A setting hen can be off the nest 15 to 20 minutes or a little longer at one time without harming the embryos, unless the weather is extremely cold. If she remains off too long, the embryos will be chilled too much. Then, some of the chicks may be weakened, and some of the embryos will die and not hatch.

7. If an embryo dies during incubation, does it feel pain?

In most cases, no. The embryo just sort of goes to sleep. In the case of severe jolting, extreme heat or cold, or similar causes of death, the embryo might experience some discomfort.

8. Why does the eye get so big; and why does it grow so fast?

We do not have the exact answer to this. However, it is possible that both size of the eye and speed of its growth could be at least partially due to the eye being so very complex and so important. This considerable time is needed to completely form and develop it.

9. Why does the heart grow on the outside of the body at first?

We do not know why it does so. It is known that the heart helps to circulate blood both in the embryo's circulatory system and in the membranes outside the embryo that carry food to the embryo as it develops.

10. If you break open the shell, say on the 8th or 9th day, how long can the embryo live?

The length of time it will live varies with the conditions around it, such as temperature. It is not likely to live more than 5 to 10 minutes in most instances. It is possible to remove the shell at the large end of the egg, replace it with a plastic cap, continue to incubate the egg and the embryo can then live several days.

11. Can you open the shell for the chick?

Yes, but is not recommended. To do so is frequently painful to the chick. Also, the chick is usually weakened and may die.

12. Can I find the egg tooth and keep it after it falls off?

No. It just sort of "fades" or "melts" away.

13. If I find a bird egg, such as a Robin's, can I hatch it?

It is possible, but you should not because young birds, like the Robin, require the skilled care of its parents to survive. People cannot provide the same kind of care. The baby bird will most likely die from starvation, cold or mismanagement.

14. Can we hold the chicks as soon as they hatch?

Before the chicks are handled, the hatch should be completed and the chicks should be allowed to dry completely and fluff up.

15. How can you tell if the chick is male or female?

Unless the males and females are different colors, you cannot tell them apart without special training. Trained chick sexors can tell the difference by (1) examining the chick's internal organs or (2) observing the difference in the length of the chick's wing feathers at about one day of age.

16. Can I take the chicks home? If my uncle owns a farm? If I move to a farm?

No. You should not take the chicks home unless your family or some relatives live on a farm and have the proper equipment and buildings and the knowledge to care for them appropriately.

17. Are you going to kill the chicks when you take them from the class?

No. A farmer will take them and care for them.

18. How long after a chick hatches does it become an adult?

Those chickens raised for egg production need to develop for about five months. Those raised for meat take longer — about six months.

19. How long do chickens live?

Broilers reach market age in six to eight weeks. On most commercial egg farms, laying hens have completed their usefulness when they are 18 to 20 months old. Records show that when chickens are allowed to live out their lives naturally, many of them will live in the range of six to ten years. Some claims have been made of some chickens living as long as 22 years.

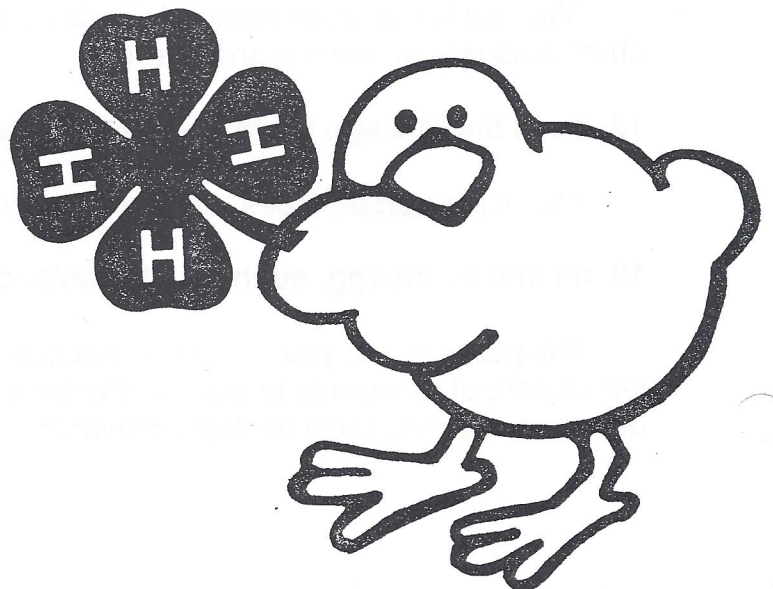



Awarded To

For Eggcellent Work

on

by

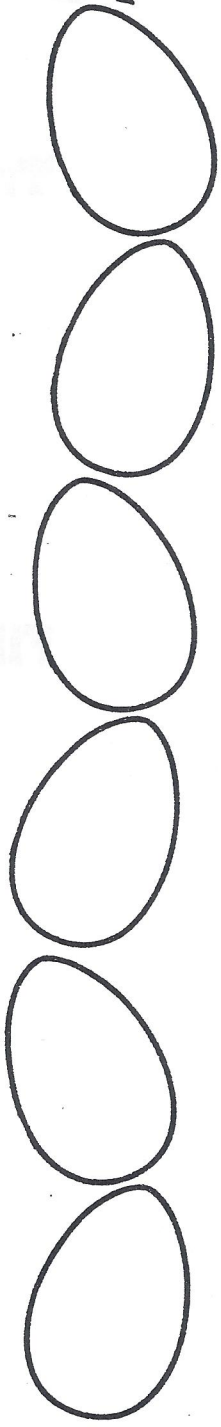

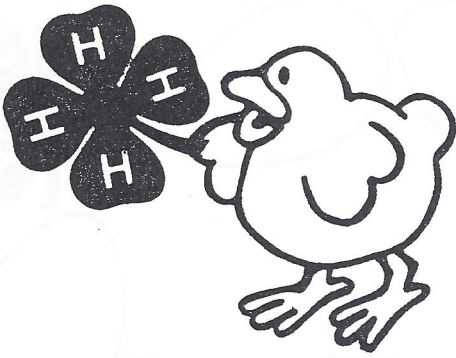

The Incredible Egg

Name _____
Post Test

True or False (Circle)

- T F 1. Eggs should be hatched at 100.5° F.
- T F 2. Eggs in an incubator should not be turned every day.
- T F 3. As the baby chick inside the eggs grows, it gives off carbon dioxide.
- T F 4. A flashlight will not shine through a normal chicken egg.
- T F 5. A chicken egg takes longer to hatch than a turkey egg.

Fill in the Blanks or Circle the Correct Answer

6. Name 3 parts of an egg: _____

7. How many calories does an average egg contain?
a. 20
b. 80
c. 300
d. 600
8. Eggs belong to what food group?
a. Fruits and vegetables
b. Bread and cereal
c. Meat
d. Milk
9. How many days does it take for a chicken egg to hatch?
a. 12
b. 21
c. 32
d. 40
10. The _____ in an incubator is measured using a thermometer.
a. oxygen
b. humidity
c. temperature

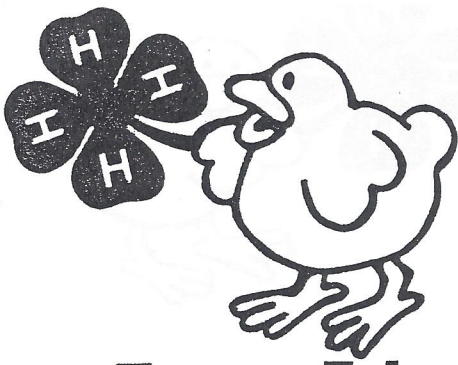

The Incredible Egg

Name ANSWER KEY
Post Test

True or False (Circle)

- T F 1. Eggs should be hatched at 100.5° F.
- T F 2. Eggs in an incubator should not be turned every day.
- T F 3. As the baby chick inside the eggs grows, it gives off carbon dioxide.
- T F 4. A flashlight will not shine through a normal chicken egg.
- T F 5. A chicken egg takes longer to hatch than a turkey egg.

Fill in the Blanks or Circle the Correct Answer

6. Name 3 parts of an egg: SHELL, YOLK, AIR CELL
ALBUMEN, SHELL MEMBRANE
CHALAZAE, GERM SPOT
7. How many calories does an average egg contain?
a. 20
 b. 80
c. 300
d. 600
8. Eggs belong to what food group?
a. Fruits and vegetables
b. Bread and cereal
 c. Meat
d. Milk
9. How many days does it take for a chicken egg to hatch?
a. 12
 b. 21
c. 32
d. 40
10. The _____ in an incubator is measured using a thermometer.
a. oxygen
b. humidity
 c. temperature

Eggstra-Special Egg Laying Creatures

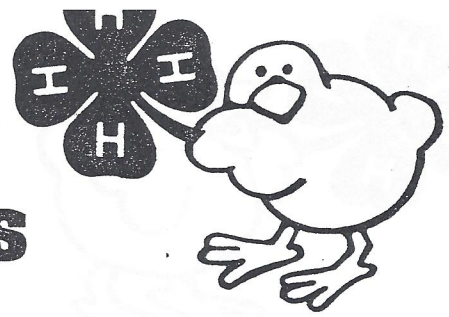

Across

1. A small American Game Bird — Bobwhite is one variety.
2. The only egg laying mammal.
3. Symbolic bird of the United States of America.
4. Waterfowl larger than a duck and smaller than a swan. Duck, Duck, ____.
5. Extinct long-tailed reptiles, often large in size.
6. Usually seen swimming in a farm pond. ____, ____, Goose.
7. You can find this bird's eggs in any supermarket; this bird is also the San Diego Padre's mascot.
8. An extinct bird of the Island of Mauritius that is related to the pigeon.

Down

1. A reptile of land, freshwater or marine life having a toothless horny beak. Some varieties — snapping, box.
2. A slithering reptile. Some produce deadly venom when they bite.
3. A very swift, two-toed bird that does not fly. It can weight as much as 300 pounds and it is the largest of existing birds.
4. This bird was once used to carry messages from one place to another.
5. The State Bird of Ohio.
6. The most common meat for an American Thanksgiving Dinner.

Helpful Hints

Cardinal
Dinosaur
Duck

Ostrich
Platypus
Snake
Goose

Chicken
Dodo
Eagle
Turtle

Pigeon
Quail
Turkey

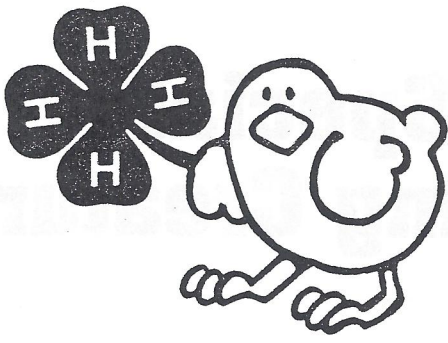

Eggstra-Special Egg Laying Creatures

Name _____

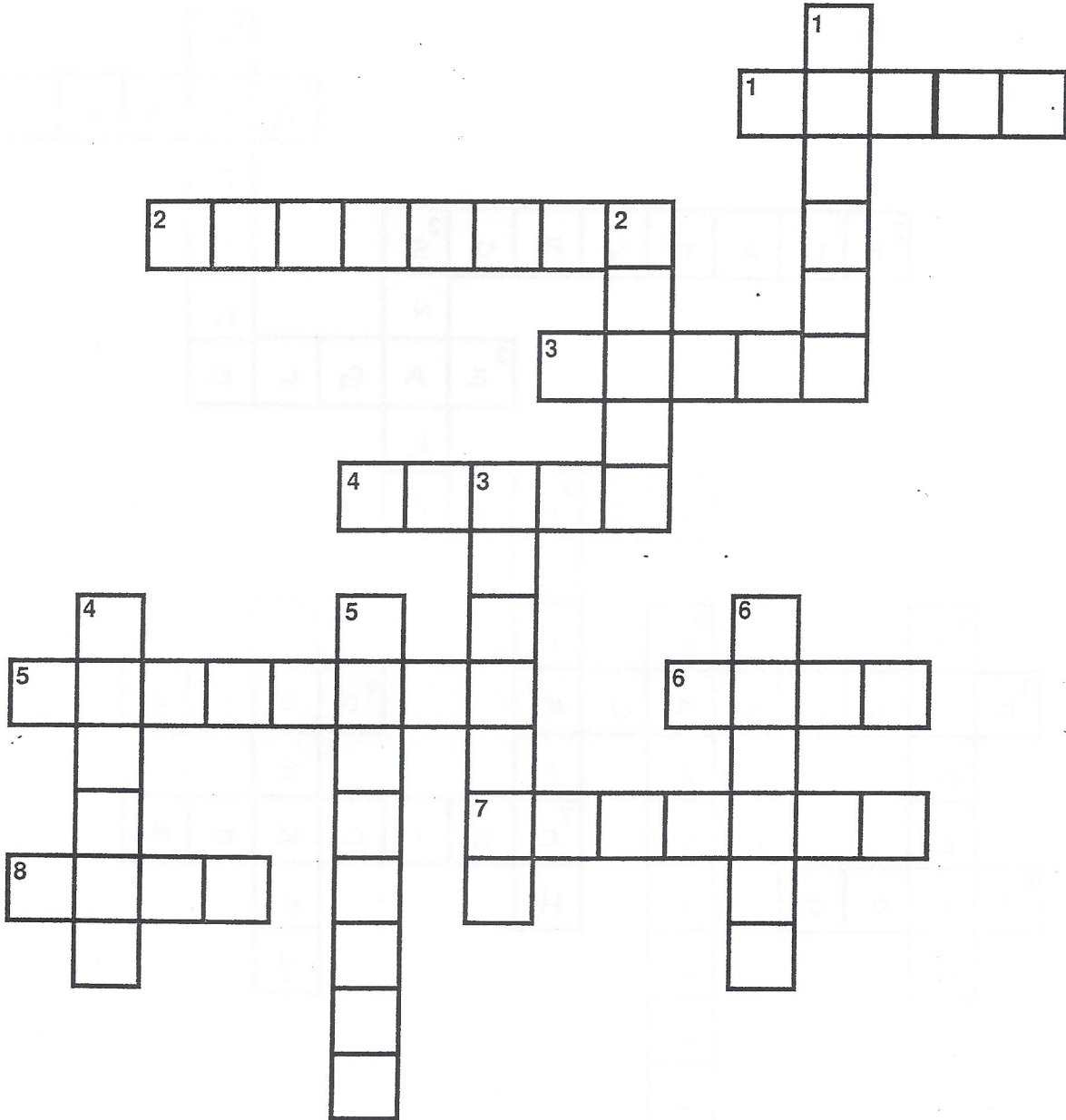

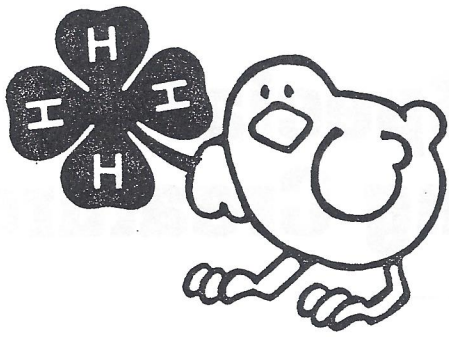

Eggstra-Special Egg Laying Creatures

Name ANSWER KEY

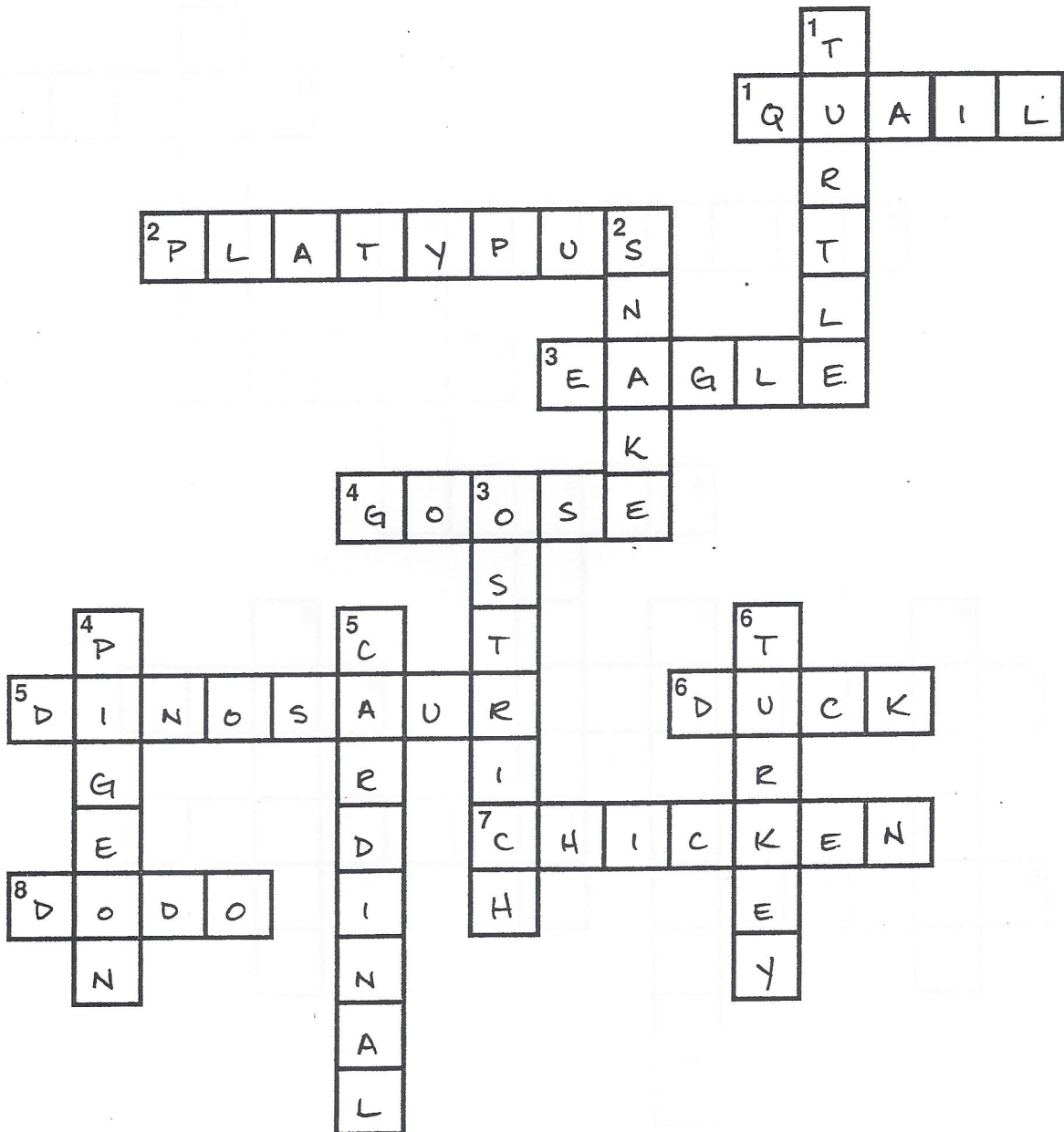

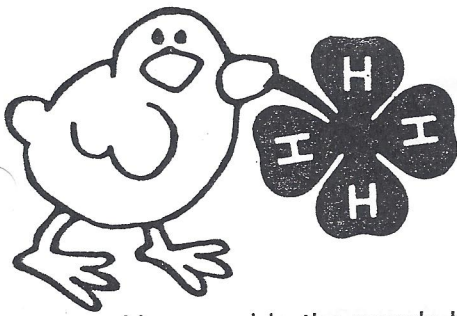

Scrambled Eggs

Name _____

Unscramble the words below and you will have the seven parts of an egg.

1. LHLES _____
2. KOLY _____
3. LELC RIA _____
4. BULANME _____
5. BAMRMEEN LLSHEL _____
6. ZLAAAACH _____
7. TOPS RMEG _____

More Egg-citement. Circle the correct answer.

8. Eggs are hatched in an _____.
 - a. inqubator
 - b. incubator
 - c. incubater
9. Growing chicks require plenty of _____ for a healthy start.
 - a. oxyjen
 - b. oxigen
 - c. oxygen
10. Eggs hatch at either 100.5° _____ or 38° _____.
 - a. Fairenheight and Selcius
 - b. Fahrenheit and Celsius
 - c. Fahrenheit and Cellcius
11. Temperature is measured using a _____.
 - a. thermometer
 - b. thermmeter
 - c. thermomater
12. A science that deals with the growth and development of a chick is called _____.
 - a. embriology
 - b. embryolgy
 - c. embryology

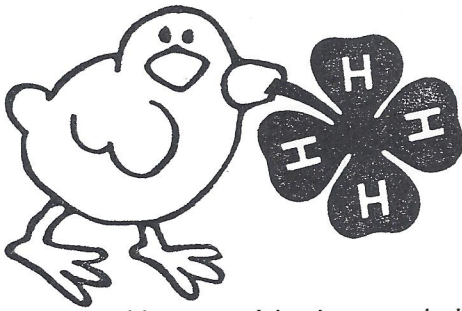

Scrambled Eggs

Name ANSWER KEY

Unscramble the words below and you will have the seven parts of an egg.

1. LHLES SHELL
2. KOLY YOLK
3. LELC RIA AIR CELL
4. BULANME ALBUMEN
5. BAMRMEEN LLSHEL SHELL MEMBRANE
6. ZLAAAECH CHALAZAE
7. TOPS RMEG GERM SPOT

More Egg-citement. Circle the correct answer.

8. Eggs are hatched in an _____.
 - a. inqubator
 - b. incubator
 - c. incubater
9. Growing chicks require plenty of _____ for a healthy start.
 - a. oxyjen
 - b. oxigen
 - c. oxygen
10. Eggs hatch at either 100.5° _____ or 38° _____.
 - a. Fairenheight and Selcious
 - b. Fahrenheit and Celsius
 - c. Fahrenheight and Cellcious
11. Temperature is measured using a _____.
 - a. thermometer
 - b. thermmeter
 - c. thermomater
12. A science that deals with the growth and development of a chick is called _____.
 - a. embriology
 - b. embryolgy
 - c. embryology

References

1. *The Avian Embryo*, Extension Bulletin 633, The Ohio Cooperative Extension Service, The Ohio State University, 1978.
2. *Best of Volume I, Copycat Magazine*, 2625 Lathrop Ave., Racine, WI 53405, 1985-86.
3. *Egg Basics: A Seven Segment Learning Handbook*, Ohio Egg Marketing Program, 674 W. Lane Ave., Columbus, OH 43210, (614) 292-2089.
4. *Eggcentric Eggs*, Learning Tree Mini-Unit, Zephyr Press, 430 S. Essex Ln., Tuscon, AZ 85711.
5. *Eggyclopedia*, American Egg Board, 1460 Renaissance Dr., Park Ridge, IL 60068.
6. *Eggory*, Georgia Egg Commission, State Farmer's Market, Forest Park, GA 30050.
7. *Extraordinary Eggs*, 4-H Project Manual 488, The Ohio Cooperative Extension Service, The Ohio State University, 1988.
8. Fisher, Aileen. *Widening Circles: Level 8*. Harcourt, Brace and Jovanovich, 1979.
9. Pursell-Sanford, Margaret. *Jessie the Chicken*. Carol Rhoda Books, 241 First Ave. N., Minneapolis, MN 55401, 1977.

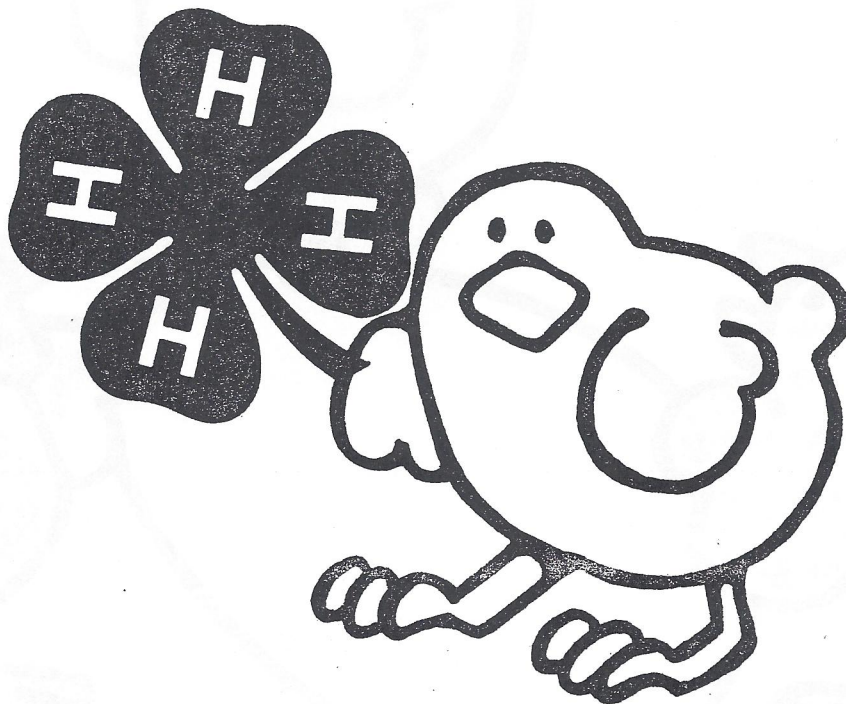

*Extension Center
Court House
Palmyra, Mo. 63461*

T H E 4 - H
PLEDGE

I pledge
My Head to clearer thinking,
My Heart to greater loyalty,
My Hands to larger service and
My Health to better living, for
My Club, My Community, My Country
and My World.

