

# Simple Home Repairs: Shingle Roofs

**Patricia Klobe**  
Department of Environmental Design

Does your roof leak? You may have damaged or missing shingles. You can repair it yourself.

## If you decide to do the repair, you will need:

- Two ladders (one for climbing to the roof and one for work on top of the roof)
- Replacement shingles
- Asphalt roofing cement
- Roofing nails
- Small pieces of sheet metal
- Claw hammer
- Hacksaw
- Small trowel

## 1 Wood shingles

1. If the roof leaks, find the location of the leak as nearly as possible from inside.
2. Place and secure the ladder.
3. Examine the condition from the outside.
4. If the shingle is cracked, it is better to repair the crack than to replace the shingle. To repair a small crack (1/4 inch or less), pull out loose splinters so that only the large, solid pieces remain. Check the roofing material under the shingles to determine where the nails should go. Sometimes shingles are nailed to wood slats spaced 4 or 5 inches apart (Figure 1). Sometimes they are nailed to wood sheathing.
5. With the loose splinters removed, butt the solid pieces tightly together and nail the split shingle together with galvanized roofing nails (Figure 2). Do not drive the heads of

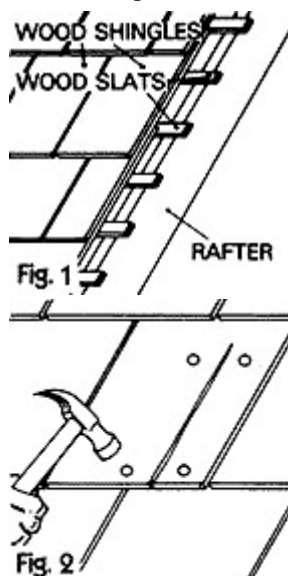

the nails into the shingle and damage its surface!

6. Cover the crack fully with asphalt roofing cement (Figure 3). To finish, cover the nail heads with cement.

7. If the crack is wide, add a sheet metal patch. Drive a square piece of sheet metal under the cracked shingle (Figure 4). **Make sure that the top of the sheet metal goes beyond the upper edge of the crack.** Complete the job as described above for the small crack.

- 8.
9. If shingles are damaged beyond repair, replace them (Figure 5). This can be more tricky than repairing a cracked shingle.

Remove the damaged shingle. Cut it into smaller pieces with a screwdriver or chisel that can be removed by pulling with your fingers.

Using a hacksaw blade, cut the nails off even with the wood slats or sheathing (Figure 6). Since shingles overlap, you may have to pry up the shingle above enough to get at all the nails. Take care not to crack the good shingle.

Measure the empty space and cut a replacement shingle to fit. Using a wood block and hammer, drive in the replacement shingle (Figure 7).

Nail the new shingle in place with galvanized roofing nails (Figure 8). Cover the nail heads with a small amount of asphalt cement.

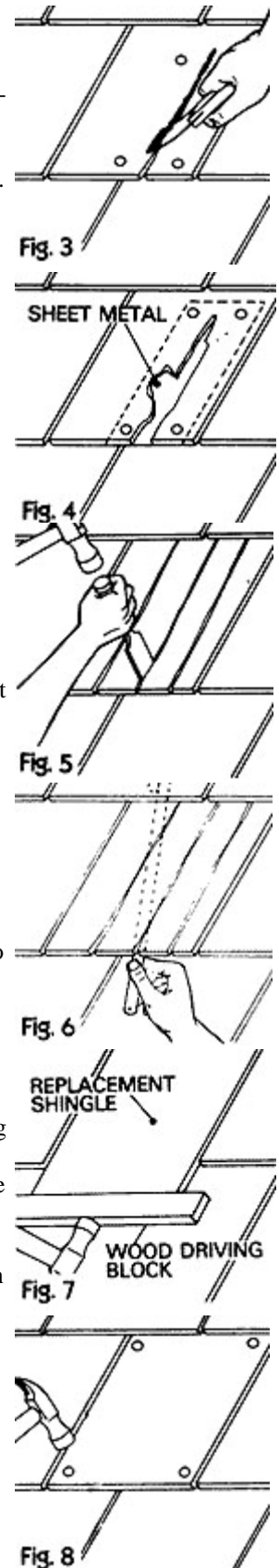

## Asphalt shingles

1. Locate the damaged area and examine the condition.
2. If the shingle does not need replacing, simply raise the damaged or torn shingle and apply an ample amount of asphalt cement to the underside (Figure 9). Now press the shingle firmly into place and nail it down with broad-headed, galvanized roofing nails. (Always remember to apply asphalt cement to the nail heads.)
3. If the shingle needs replacing, select a strip the same as the piece to be replaced. Your asphalt roofing will usually come in shingle strips as shown in Figure 10. Some roofing is in single, separate shingles (Figure 11).

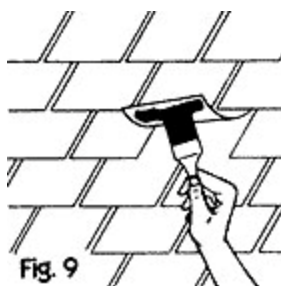

Fig. 9

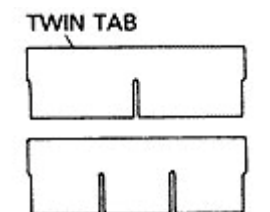
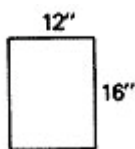

Fig. 10  
12" x 36"  
SHINGLE STRIPS



INDIVIDUAL SHINGLE

Fig. 11

4. Raise the shingle above the damaged one. Pull the nails from the damaged shingles with the claw hammer (Figure 12). If nails cannot be reached with a hammer, cut them off with a hacksaw blade.
5. Remove the damaged shingle. Slip the new shingle into place (Figure 13).
6. Nail the new shingle in place with broad-headed, galvanized roofing nails. Use two nails on each tab to make 6 nails to each full shingle strip (Figure 14). The shingle should be "blind nailed." That is, the nails should be covered by the upper shingles when they are lowered into place.
7. Apply a dab of asphalt cement over the nail heads and lower the upper shingles into place.

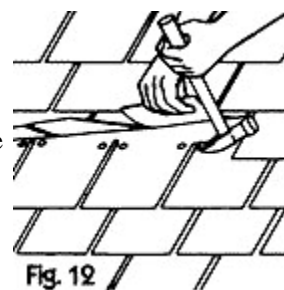

Fig. 12

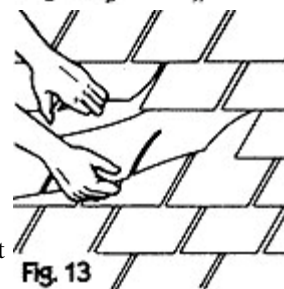

Fig. 13

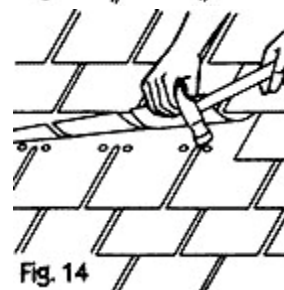

Fig. 14

This guide was reprinted from the United States Department of Agriculture publication, Program Aid number 1193, Extension Service.

GH5942, reviewed October 1993

## Related MU Extension publications

GH5929, Simple Home Repairs: Should You Make Repairs?<http://extension.missouri.edu/publications/DisplayPub.aspx?P=GH5929>  
 GH5931, Simple Home Repairs: Wood Steps<http://extension.missouri.edu/publications/DisplayPub.aspx?P=GH5931>  
 GH5932, Simple Home Repairs: Cracks in Concrete Sidewalks<http://extension.missouri.edu/publications/DisplayPub.aspx?P=GH5932>  
 GH5933, Simple Home Repairs: Wood Porch Flooring<http://extension.missouri.edu/publications/DisplayPub.aspx?P=GH5933>  
 GH5934, Simple Home Repairs: Splash Blocks and Drywells<http://extension.missouri.edu/publications/DisplayPub.aspx?P=GH5934>  
 GH5936, Simple Home Repairs: Caulking and Filling Cracks Around Windows and Doors<http://extension.missouri.edu/publications/DisplayPub.aspx?P=GH5936>  
 GH5937, Simple Home Repairs: Storm Doors and Windows<http://extension.missouri.edu/publications/DisplayPub.aspx?P=GH5937>  
 GH5938, Simple Home Repairs: Screened Doors and Windows<http://extension.missouri.edu/publications/DisplayPub.aspx?P=GH5938>  
 GH5939, Simple Home Repairs: Exterior Painting<http://extension.missouri.edu/publications/DisplayPub.aspx?P=GH5939>  
 GH5944, Simple Home Repairs: Flat Roofs<http://extension.missouri.edu/publications/DisplayPub.aspx?P=GH5944>

Order publications online at <http://extension.missouri.edu/explore/shop/> or call toll-free 800-292-0969.